



**Bogantilla**

— SDN BHD —

FLOURISHING YOUR BUSINESS

**BOGANVILLA SDN. BHD.**

OIL & GAS SUPPLIER / SERVICE PROVIDER

**LOCKOUT / TAGOUT SOLUTIONS**

---

**SAFETY**

**LOCKOUT TAGOUT**

**PRODUCT CATALOG**

**2026**

Industrial lockout/tagout products presented under Bogantilla branding for client review, procurement, and project documentation.

FLOURISHING YOUR BUSINESS

**LOCKOUT**

**TAGOUT**

**SAFETY SUPPLY**

---

**FLOURISHING YOUR BUSINESS**

Lot 106, 1st Floor, Benoni Commercial Centre, 89600 Papar, Sabah

+60109337239



## FLOURISHING YOUR BUSINESS

### CORE SCOPE

- Lockout/tagout product supply
- Safety equipment sourcing
- Procurement coordination
- Handover documentation support
- Client artwork, numbering, and colour-code coordination

# COMPANY PROFILE

## BOGANVILLA SDN. BHD.

Oil & Gas Supplier / Service Provider

Boganvilla Sdn. Bhd. supports industrial clients with safety product supply, procurement coordination, and project documentation. This rebranded catalog is prepared for lockout/tagout product selection and client-facing submission without supplier contact details.

### COMPANY DETAILS

COMPANY	Boganvilla Sdn. Bhd.
ADDRESS	Lot 106, 1st Floor, Benoni Commercial Centre, 89600 Papar, Sabah
CONTACT	+60109337239
SERVICE	Industrial supply, lockout/tagout products, and supporting documentation

### SUPPLY NOTE

Final item availability, product options, colour coding, tag wording, numbering, and packaging requirements should be confirmed before order processing.

LOCKOUT & TAGOUT	001-004	PNEUMATIC LOCKOUT	098-101
KEY CHARTING SYSTEM	005-008	CABLE LOCKOUT	102-108
SAFETY PADLOCK	009-038	PADLOCK STATION	109-130
TAGS & SPECIAL PEN	039-046	SAFETY LOCKOUT KIT	131-139
SAFETY LOCKOUT HASP	047-055	SEAL LOCK	140-142
ELECTRICAL LOCKOUT	056-085	GLOVE CLIP	143-145
VALVE LOCKOUT	086-097	MSDS BOX	146-148



# SAFETY LOCKOUT TAGOUT



## SAFETY LOCKOUT TAGOUT

What is LOTO?(Lock out/Tag out=LOTO)

When the equipment or tool is being repaired, maintained or cleaned, the power source related to the equipment need to be cut off, so that the equipment cannot be started, and all energy sources (power supply, hydraulicsource, air source, etc.) are turned off.

Lock out	Lockout is using the safety and other equipment to lock the machine to isolate from unauthorized operations and ensuring each worker's safety until the work is finished
Tag out	Tagout is using for warning the people that the energy source or equipment is locked that can not be operated optionally.
Disconnecting means	One piece or one group equipment can disconnect the energy source or the power supply circuit
LOTO	In order to ensure that the equipment energy is turned off ,the equipment is kept in a safe state.Prevent accidental injury to the staff or related person inside or next to equipment caused by the equipment being accidentally operated

### Why should use LOTO?

LOTO is in order to prevent the worker from the danger that caused by the machine start accidentally,the equipment launch abnormal,the energy source release when the worker want to repair or maintain it,so that it can keep the workers personal security.The Key of LOTO is to cut off the connection between machine and power source,lock on the source,release residual power.

### Regulations and standards for LOTO

#### China sets national standards for lockout

In 2009, the General Administration of Quality Supervision, Inspection and Quarantine of the People's Republic of China and the China National Standardization Administration issued the national standard GB/T2-2009 Safety Requirements for Electrical Equipment Application Sites-Part 2: Safety Measures for Operation in Power-off.

On May 12, 2017, the General Administration of Quality Supervision, Inspection and Quarantine of the People's Republic of China and the National Standardization Administration of the People's Republic of China issued the National Standard GB/T33579-2017 safety of machinery- control method of hazardous energy -lockoutl tagout.The national standard began machinery on December 1, 2017.

#### Interpretation of the national standard GB/T33579-2017 on the scheme of lockout/tagout:

Establishing a control system and use LOTO procedures to prevent accidental release or transmission of machine energy.

#### Requirements of the national standard GB/T33579-2017 on the scheme of lockout/tagout:



The corresponding laws and regulations of major European and American countries on lockout/tagout

## SAFETY LOCKOUT TAGOUT

Bogantilla LOTO products are supplied for industrial safety lockout and tagout requirements.

Requirement	Durable	rugged	standardized	identifiable	other security purposes
Description	It is made of materials that are resistant to various environments	cannot be removed unless use violent force	clear distinction is made by the difference in color, shape, or size	indicating that authorized personnel	using for controlling equipment energy only
BGV LOTO Products	✓	✓	✓	✓	✓

### When & Where should use LOTO?

- Daily maintenance, adjustment, cleaning, inspection and commissioning for equipment. Enter into the limited space, hotwork, dismantling work and soon in the tower, tank, electrified body, kettle, heat exchanger, pumps and other facilities.
- Operation involving high voltage including the operation under the high-tension cable.
- Operation require closing the safety system temporary.
- Operation during maintenance and commissioning of non-processing.



### LOCKOUT & TAGOUT REQUIREMENTS

- When some persons are authorized to perform the same task, each staff must complete its own lockout and tagout process, rather than others.
- Never authorize others to remove your lockout device.
- Only operate the device that has been locked by safety lockout.
- When you shift, must not arbitrarily terminate the original lockout device listing until the carry personnel is in accordance with the requirements of the lockout tagout, then remove the original lockout or tagout. At the same time, the new carry personnel should confirm the LOTO is safe and reliable before operation.
- Never let your security rely on others' LOTO, always remember use your safety lockout protect yourself.
- Use the correct lockout, so please find the item in the catalog according to the actual situation.
- Make sure that safety lockout is able to withstand the environment in which it is located like dusty, humid and soon.
- Safety lockout and safety tagout should be combined in usage, and can not replace each other.
- Since 2nd January, 1990, whenever the machinery and equipment change, overhaul, remould or innovate, even install new machinery and equipment for the machines and equipment, the energy isolating device and the equipment should be designed to fit the safety lockout and tagout.
- Operators should test the ability control rules at least once a year, ensure the standard procedures and requirements are implemented. The authorized employees perform regular inspection, rather than the staff who perform energy control rules carry out testing.
- If there is a possibility that the storage of energy should be saved to reach the dangerous level. It should continue to be verified, repair or maintain the energy source, until the danger doesn't exist.
- Whenever external maintenance personnel is take part in the maintenance activities within the permission, the site operators and the external operators shall inform lockout or tagout rules to each other.

## SAFETY LOCKOUT TAGOUT

### THE PROCEDURE OF LOTO (LOCKOUT/TAGOUT)

#### STEP 1: PREPARE

Prepare to close the source of energy. The type of energy is electric energy, mechanical energy, air energy and soon. Besides the accident this energy cause. Prepare the lockout and tagout.

#### STEP 2: NOTICE

Notice the person who effect on isolating and protecting the machine and the manager who is working with the machine.

#### STEP 3: CLOSE

Close the machine or equipment.

#### STEP 4: LOCK

Lock the closed equipment or machine after make sure that nobody turn on the valve and the switch. Then you can affix on the warning label or lock wittag to avoid operate miss.

#### STEP 5: TEST

Test all equipment and circuit make certain all of them have been locked out.

#### STEP 6: MAINTAIN

Maintain the machine according to the applied situation of the equipment.

#### STEP 7: RECOVER

Recover the equipment and circuit while remove the lockout and tagout. And inform all workers after provide the energy.

We can provide your factory with professional and systematic locking compliance overall service



# KEY MANAGEMENT SYSTEM



## KEY MANAGEMENT SYSTEM

Function and method of using key tooth

### KD Keyed Different

One key can only open one padlock;  
Advantages: Your padlock cannot be opened by the key of other padlocks.

### KA Keyed Alike

The quantity is determined according to your needs

One key can open all padlocks in the same group;  
Advantages: multiple KA groups can be customized, one key can open all padlocks in the same group, but padlocks can not open each other between the multiple KA groups.

### MK Master keyed

The quantity is determined according to your needs

### KDMK

### KAMK

The quantity is determined according to your needs

One key can open all padlocks from several KD groups;  
Advantages: padlocks from KD groups can be opened by master key.

### GMK Grand Master Keyed

One key can open all padlocks from several groups of KD, KA or MK.



## KEY MANAGEMENT SYSTEM

### THE COLOR OF KEYCOVER

We can provide 8 kinds of different colors.



For example, the coat of master key is black, the sub key is uncoated, then can find the master key easily.



Different department use different colors. For example the red padlocks with red keys are allotted to electrical maintenance department; the yellow groups allot fitter department; the blue groups are allotted production department. In this condition, the color can stand for the responsible department, manage easily.



### KEY REGISTER MANAGEMENT

We can register the code that laser print on the padlock and key. In the case that you lost the padlock or the key, we can make the new one depend on the code for you.



### Key Management System Ordering System Example

For example: BD-G01-KD, the quantity is 100;

For example: BD-G01-KA, 200 pieces;

For example: BD-G01-KDMK, do 2 groups, 300pcs KD each group, have MK keys to open all the 600pcs;

For example: BD-G01-KAMK, do 3 groups, 300pcs each group, no matter KA within each group or KD within each group, the padlocks between the 3 groups can not open each other, then have MK keys to open all the 900pcs.

Except Jacket padlocks and Laminated padlocks, other padlock series can choose key management systems. If the key management system has more complex requires for groups, please refer to this page or call for consultation.

## KEY MANAGEMENT SYSTEM

### Selection of key system groups

Zinc alloy cylinder key system groups			
Key system	Groups qty	Max padlock qty in the group	Serial number
KD	none	1-99999	-
MK	6	860	-
	15	710	-
	30	580	-
GMK	6	80	MK3A series
	15	24	MK3B series

Note: If have more complex requires of groups, please call for consultation.

Brass alloy cylinder key system groups			
Key system	Groups qty	Max padlock qty in the group	Serial number
KD	none	1-99999	-
MK	1	36000	00 series
	6	5000	10 series
	30	1000	20 series
GMK	4	6000	GMK3 series
	23	1000	GMK4 series









Note: If have more complex requires of groups, please call for consultation.

# SAFETY PADLOCK



## CUSTOMIZATION OPTIONS







### Product Appearance

Steel/SS Shackle (Dia 6.2mm)	Nylon Shackle (Dia 6.2mm)	SS Cable Shackle (Dia 3.2mm)	Ultrasonic SS Thin Shackle (Dia 4mm)
			
SS Thin Shackle (Dia 5mm)	Nylon Thin Shackle (Dia 5mm)	SS Thin Shackle (Dia 4mm)	Nylon Thin Shackle (Dia 4mm)
			

### Padlock Label



### Padlock Body Shell And Brand

EB	A	B	C	D	E
					

### Individual Packing Box



**BD-G00 SERIES**  
**SAFETY PADLOCK**



**Product Features**

- The lock body is made of engineering plastic reinforced nylon PA, with an integrated shell design, which is more durable, resistant to temperature difference (-20°C-+100°C) and impact, and the metal shackle is chrome plated.
- Contain "DANGER" and "PROPERTY OF" standard labels on front and back (Can customized luminous PVC labels). Label language can be customized.
- Resistance of chemical, extreme temperatures and UV rays.
- Can customized self elastic padlock: the lock shackle pops up automatically when unlocking, and the cylinder locks automatically when locking.
- Key retaining to ensure the padlocks are not
- Laser key numbers or print logo on body sides or the front or the back.
- 5 types of body and 8 colors for your choice.

BD - [ ] G [ ] 0 [ ] 1

- Body Color
- |           |           |
|-----------|-----------|
| 1: Red    | 5: Black  |
| 2: Yellow | 6: White  |
| 3: Blue   | 7: Orange |
| 4: Green  | 8: Purple |

Shackle Specification

Code	Material	Inner Height (mm)	Dia (mm)
0	Steel/SS	38	6.2
1	Nylon	38	6.2
2	Steel/SS	76	6.2
3	Nylon	76	6.2
4	SS cable	cable 150	3.2
5	Steel/SS	25	6.2
5□N	Nylon	25	6.2
6	Steel	20	6.2

Note: Shackle standard do steel by default. If require stainless steel shackle, pls tell the sales

Cylinder Material  
 no code: Zinc alloy cylinder  
 T: Brass cylinder

Padlock Series

Self Elasticity And Key Retaining  
 no code: Standard nonself elastic and with key retaining function  
 Z: Elastic but without key retaining function

Enterprise Code



Zinc alloy cylinder padlock



Brass cylinder padlock

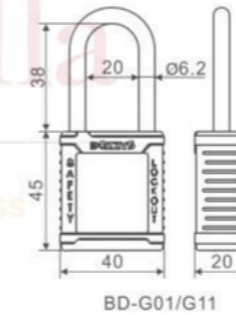

BD-G01/G11

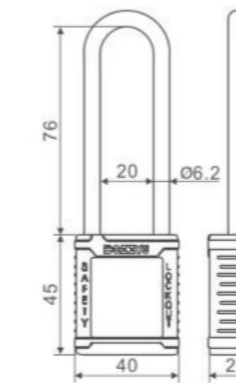

BD-G21/G31

**Product Selection**

Part Code	Shackle (First digit)			Lock body		Lock cylinder			
	Material	Inner height (mm)	Dia (mm)	Lock Body	Color (Second digit)	Material	Autoelasticity		
BD-G01	Steel/ Stainless Steel	38	6.2	EB type by default other 5 choices A,B,C, D,E.	1: Red 2: Yellow 3: Blue 4: Green 5: Black 6: White 7: Orange 8: Purple	Standard Zinc alloy cylinder with 2 keys each lock	standard nonself elastic and with Key retaining function		
BD-G11	Nylon	38	6.2						
BD-G21	Steel/ Stainless Steel	76	6.2						
BD-G31	Nylon	76	6.2						
BD-G41	Stainless Steel cable	cable 150	3.2						
BD-G51	Steel/ Stainless Steel	25	6.2						
BD-G51N	Nylon	25	6.2						
BD-G61	Steel	20	6.2						
								can Custommade Brass cylinder (standard with 1key each lock)	can customized elastic but without key retaining function

Eg: Zinc alloy cylinder padlock model number: BD-G01; Brass cylinder padlock model number: BD-GT01; SS shackle padlock: BD-G01S; Auto-popup padlock: BD-ZG01

**Product Appearance**



SAFETY PADLOCK

SAFETY PADLOCK

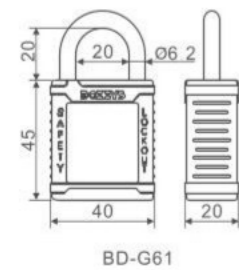
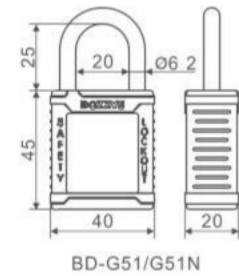
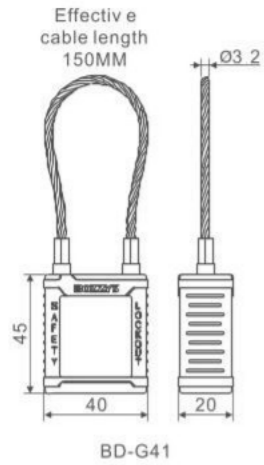

BD-G31	BD-G32	BD-G33	BD-G34	BD-G35	BD-G36	BD-G37	BD-G38
BD-G41	BD-G42	BD-G43	BD-G44	BD-G45	BD-G46	BD-G47	BD-G48
BD-G51	BD-G52	BD-G53	BD-G54	BD-G55	BD-G56	BD-G57	BD-G58
BD-G51N	BD-G52N	BD-G53N	BD-G54N	BD-G55N	BD-G56N	BD-G57N	BD-G58N
BD-G61	BD-G62	BD-G63	BD-G64	BD-G65	BD-G66	BD-G67	BD-G68

**BD-G00DP SERIES  
 SAFETY PADLOCK  
 (DUST-PROOF COVER)**

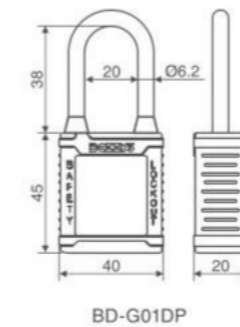

**Product Features**

- Durable, lightweight with non-conductive PA lock body, withstand temperature from -20°C to 150°C, shock resistance; the shackle is chrome plating; the non-conductive shackle is made from Nylon, ensure the strength and deformation fracture not easily.
- Contain "DANGER" and "PROPERTY OF" standard labels on front and back. Labels language can be customized.
- Resistance of chemical, extreme temperatures and UV rays.
- Key retaining to ensure the padlocks are not left unlocked.
- Laser key numbers or print logo on body sides or the front or the back.
- 5 types of body and 8 colors for your choice.
- Can customized luminous PVC labels.

**Product Selection**

Part Code	Shackle (First digit)			Lock body		Lock cylinder	
	Material	Inner height (mm)	Dia. (mm)	Lock Body	Color (Second digit)	Material	Autoelasticity
BD-G01DP	Steel/ Stainless Steel	38	6.2	EB type by default  other 5 choices A, B, C, D, E	1: Red 2: Yellow 3: Blue 4: Green 5: Black 6: White 7: Orange 8: Purple	Standard Zinc alloy cylinder with 2 keys each lock	standard nonself elastic and with key retaining function
BD-G11DP	Nylon	38	6.2			can customade Brass cylinder (standard with 1key each lock)	can customade elastic but without key retaining function

Eg: Zinc alloy cylinder padlock model number: BD-G01DP; Brass cylinder padlock model number: BD-GT01DP; SS shackle padlock: BD-G01DPS; Auto-popup padlock: BD-ZG01DP

**Product Appearance**

BD-G01DP	BD-G02DP	BD-G03DP	BD-G04DP	BD-G05DP	BD-G06DP	BD-G07DP	BD-G08DP
BD-G11DP	BD-G12DP	BD-G13DP	BD-G14DP	BD-G15DP	BD-G16DP	BD-G17DP	BD-G18DP



**Dust-Proof Cover**

- Dust-proof cover made from silica gel ,specially customize for unique padlock body.
- Dust-proof cover suitable for dusty working space.
- Protect key hole from entering dust.

Part Code	Description	Cover material	Specification
BD-G01DP-B	Black dustproof cover	Dust-proof silica gel	Specially customize for unique padlock body;  Advantage: integrated, removable, soft silica gel to protect padlock body, excellent dust-proof function.

Part Code	Description	Cover material	Specification
BD-G01DP-E	Translucent dustproof cover	Dust-proof silica gel	Specially customize for unique padlock body;  Advantage: integrated, removable, soft silica gel to protect padlock body, excellent dust-proof function.

**BD-GP400 SERIES  
 SAFETY PADLOCK  
 (DUSTPROOF SLIDING COVER)**



**Product Features**

- The lock body is made of engineering plastic reinforced nylon PA, with an integrated shell design,which is more durable, resistant to temperature difference (-20°C~+100°C) and impact, and the metal shackle is chrome plated.
- Self developed push-pull dust-proof device for lock hole to prevent dust from entering the lockhole. Suitable for working space environment with large dust.
- Contain "DANGER" and "PROPERTY OF" standard labels on front and back (luminous PVC labels). Labels language can be customized.
- Resistance of chemical, extreme temperatures and UV rays.
- Can customade self elastic padlock: the lock shackle pops up automatically when unlocking, and the cylinder locks automatically when locking.
- Key retaining to ensure the padlocks are not left unlocked.
- Laser key numbers or print logo on body sides or the front or the back.
- 5 types of body and 8 colors for your choice.

**Model Number**

**BD - G P 4 6 1 1**

- Body Color
- 1:Red
  - 2:Yellow
  - 3:Blue
  - 4:Green
  - 5:Black
  - 6:White
  - 7:Orange
  - 8:Purple

Shackle Specification

Shackle:6

Code	Material	Inner Height (mm)	Dia (mm)
1	Steel	38	6.2
2	Nylon	38	6.2
3	SS	38	6.2
4	Steel	76	6.2
5	Nylon	76	6.2
6	SS	76	6.2

Shackle:1

Code	Material	Inner Height (mm)	Dia (mm)
4	SS cable	cable 38	3.2

- Shackle
- 1:Cable shackle
  - 6:Dia 6.2mm

- Body Width
- 40-44mm

- Plastic Body

- Padlock Series

- Enterprise Code



**Product Selection**

Part Code	Shackle (First digit)			Lock body		Lock cylinder	
	Material	Inner height (mm)	Dia (mm)	Lock Body	Color (Second digit)	Material	Auto-Pop Up
BD-GP4611	Steel	38	6.2	EB type by default	1: Red 2: Yellow 3: Blue 4: Green 5: Black 6: White 7: Orange 8: Purple	Zinc alloy lock cylinder (Two keys, KD)	Default Non Auto pop With key retaining feature
BD-GP4621	Nylon	38	6.2				
BD-GP4631	Stainless Steel	38	6.2				
BD-GP4641	Steel	76	6.2				
BD-GP4651	Nylon	76	6.2				
BD-GP4661	Stainless Steel	76	6.2				
BD-GP4671	Steel	25	6.2				
BD-GP4681	Nylon	25	6.2				
BD-GP4691	Steel	20	6.2				
BD-GP4111	Stainless Steel Cable	Cable length 150	3.2				

Eg: Common padlock:BD-GP4611; Auto-popup padlock:BD-ZGP4611

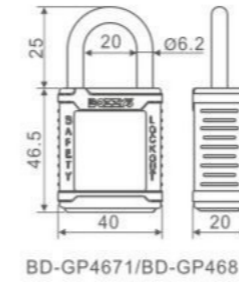

BD-GP4671/BD-GP4681

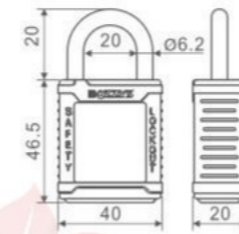

BD-GP4691

**Product Appearance**

BD-GP4611 /GP4631	BD-GP4612 /GP4632	BD-GP4613 /GT4633	BD-GP4614 /GP4634	BD-GP4615 /GP4635	BD-GP4616 /GP4636	BD-GP4617 /GP4637	BD-GP4618 /GP4638
BD-GP4621	BD-GP4622	BD-GP4623	BD-GP4624	BD-GP4625	BD-GP4626	BD-GP4627	BD-GP4628
BD-GP4641 /GP4661	BD-GP4642 /GP4662	BD-GP4643 /GP4663	BD-GP4644 /GP4664	BD-GP4645 /GP4665	BD-GP4646 /GP4666	BD-GP4647 /GP4667	BD-GP4648 /GP4668

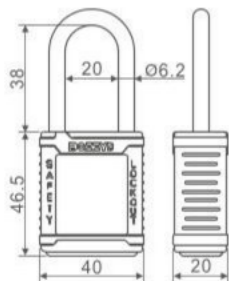

BD-G4611/G4621/G4631

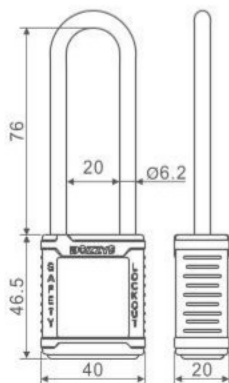

BD-G4641/G4651/G4661

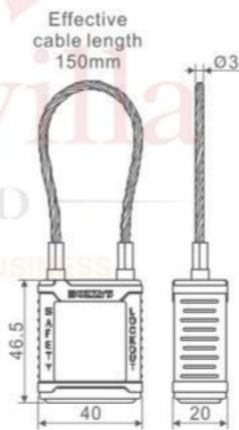

BD-GP4111

BD-GP4651	BD-GP4652	BD-GP4653	BD-GP4654	BD-GP4655	BD-GP4656	BD-GP4657	BD-GP4658
BD-GP4671	BD-GP4672	BD-GP4673	BD-GP4674	BD-GP4675	BD-GP4676	BD-GP4677	BD-GP4678
BD-GP4681	BD-GP4682	BD-GP4683	BD-GP4684	BD-GP4685	BD-GP4686	BD-GP4687	BD-GP4688
BD-GP4691	BD-GP4692	BD-GP4693	BD-GP4694	BD-GP4695	BD-GP4696	BD-GP4697	BD-GP4698
BD-GP4111	BD-GP4112	BD-GP4113	BD-GP4114	BD-GP4115	BD-GP4116	BD-GP4117	BD-GP4118

**BD-SG100 SERIES**  
**SAFETY PADLOCK**  
 (ALUMINUM PADLOCK WITH RUBBER COATED)



**Product Features**

- Lock body is made from aluminum alloy, lightweight, durable, with engineering plastic shell covering outside, UV resistance, corrosion resistance and temperature resistance (-20°C~+100°C).
- Lock shackle is made from steel with chrome plating, tension resistance 1200N when in locking state, silicone tube covering outside, so that the metal is not exposed.
- Brass lock cylinder, can be customized multi-level key management system.
- Resistance of chemical, extreme temperatures and UV rays.
- Key retaining to ensure the padlocks are not left unlocked when the shackle is open.
- Padlock labels can be rewritable, can customized luminous PVC labels.

**Product Selection**

Part Code	Shackle (The first digit)			Lock Body Color (The third digit)	Lock Cylinder
	Material	Inner height (mm)	Dia (mm)		
BD-SG101	Steel with silicone tube	40	6.4	1: Red 2: Yellow 3: Blue 4: Green 5: Black 6: White 7: Orange 8: Purple	Brass lock cylinder Non Auto pop with key retaining feature

**Product Appearance**

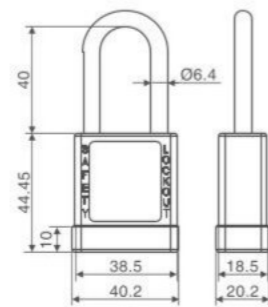

BD-SG101

**BD-G300 SERIES**  
**SAFETY PADLOCK**  
 (SMALL TYPE)



**Product Features**

- Made from engineering plastic reinforced nylon PA, integrated housing design, more durable, withstand temperature from -20°C~+100°C, shock resistance; the steel shackle is chrome plating. The nylon shackle is made from DuPont nylon, ensure the strength and deformation fracture not easily.
- Contain "DANGER" and "PROPERTY OF" writable labels, Labels language can be customized.
- UV resistant and corrosion resistant, silicon free.
- Key retaining to ensure the padlocks are not left unlocked when the shackle is open.
- Both sides and front of the lock body can be laser engraved to retain permanent identification or coding.
- A variety of lock bodies and colors are available for your choosing.
- Can customize luminous PVC labels.

**Product Selection**

Part Code	Shackle (The first digit)			Lock Body		Lock Cylinder
	Material	Inner height (mm)	Dia (mm)	Lock Body	Color (The third digit)	
BD-G301	Steel	25	4.7	EB D	1: Red 2: Yellow 3: Blue 4: Green 5: Black 6: White 7: Orange 8: Purple	Brass lock cylinder Non Auto pop with key retaining feature
BD-G311	Nylon	25	4.7			
BD-G321	Aluminum	25	4.7			
BD-G341	Stainless Steel Cable	Cable length 150	2.5			

EG: Common padlock:BD-G301; Auto-popup padlock:BD-ZG301

**Product Appearance**

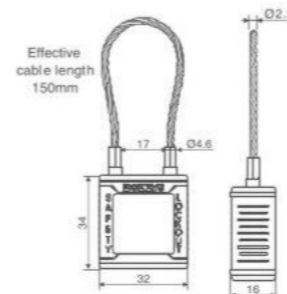
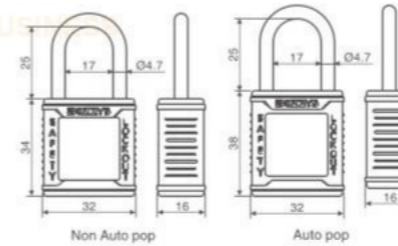
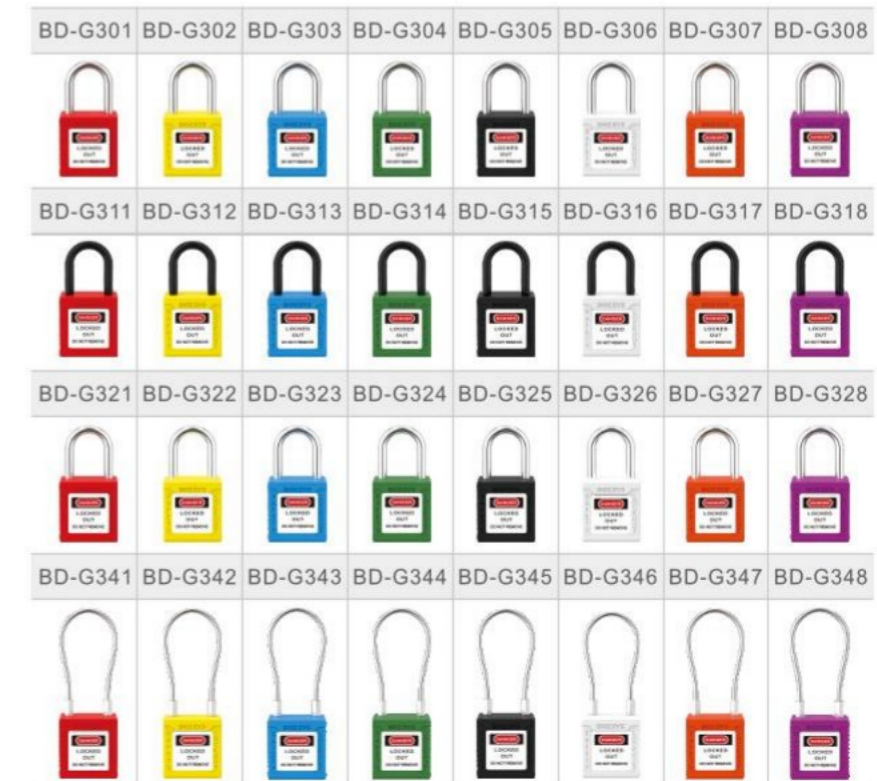

BD-G341

SAFETY PADLOCK

SAFETY PADLOCK

**BD-ZG300 SERIES  
 SAFETY PADLOCK  
 (SMALL TYPE)**



**Product Features**

- Made from engineering plastic reinforced nylon PA, Integrated housing design, more durable, withstand temperature from -30°C-+100C, shock resistance; the steel shackle is chrome plating. I the nylon shackle is made from DuPont nylon, ensure the strength and deformation fracture not easily.
- Contain "DANGER" and "PROPERTY OF" writable labels, Labels language can be customized.
- UV resistant and corrosion resistant, silicon free.
- Key retaining to ensure the padlocks are not left unlocked when the shackle is open.
- Both sides and front of the lock body can be laser engraved to retain permanent identification or coding.
- A variety of lock bodies and colors are available for your choosing.
- self-elastic brass lock cylinder The lock shackle pops up automatically when unlocking, and the lock cylinder locks automatically when locking.

**Product Selection**

Part Code	Shackle (The first digit)			Lock Body		Lock Cylinder
	Material	Inner height (mm)	Dia (mm)	Lock Body	Color (The third digit)	
BD-ZG301	Steel	25	4.7	EB	1: Red 2: Yellow 3: Blue 4: Green 5: Black 6: White 7: Orange 8: Purple	Brass lock cylinder Auto pop with key retaining feature

**Product Appearance**

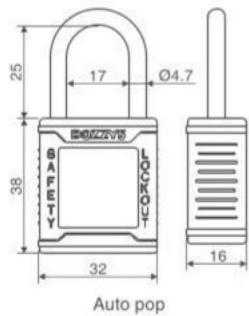

**BD-GP300 SERIES  
 SAFETY PADLOCK  
 (DUSTPROOF SLIDING COVER)**



**Product Features**

- Made from engineering plastic reinforced nylon PA, Integrated housing design, more durable, withstand temperature from -20°C-+100C, shock resistance; the steel shackle is chrome plating. I the nylon shackle is made from DuPont nylon, ensure the strength and deformation fracture not easily.
- Contain "DANGER" and "PROPERTY OF" writable labels, Labels language can be customized.
- UV resistant and corrosion resistant, silicon free.
- Key retaining to ensure the padlocks are not left unlocked when the shackle is open.
- Both sides and front of the lock body can be laser engraved to retain permanent identification or coding.
- A variety of lock bodies and colors are available for your choosing.
- Can customize luminous PVC labels.

**Product Features**

Part Code	Shackle (The first digit)			Lock Body		Lock Cylinder
	Material	Inner height (mm)	Dia (mm)	Lock Body	Color (The third digit)	
BD-GP3401	Steel	25	4.7	EB D	1: Red 2: Yellow 3: Blue 4: Green 5: Black 6: White 7: Orange 8: Purple	Brass lock cylinder Non Auto pop with key retaining feature
BD-GP3411	Nylon	25	4.7			
BD-GP3421	Aluminum	25	4.7			
BD-GP3111	Stainless Steel Cable	Cable length 150	2.5			

**Product Appearance**

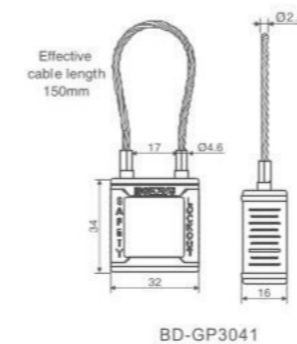
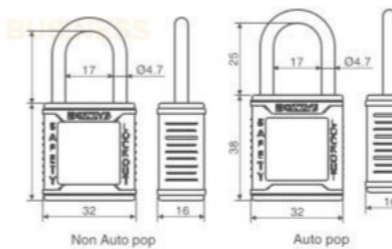

SAFETY PADLOCK

SAFETY PADLOCK

**BD-G700 SERIES  
 SAFETY PADLOCK  
 (4MM LOCK SHACLE TYPE)**



**Product Features**

- Made from engineering plastic reinforced nylon PA, Integrated housing design, more durable, withstand temperature from -20°C-+100C, shock resistance; the steel shackle is chrome plating. I the nylon shackle is made from DuPont nylon, ensure the strength and deformation fracture not easily.
- Contain "DANGER" and "PROPERTY OF" writable labels, Labels language can be customized.
- UV resistant and corrosion resistant, silicon free.
- Key retaining to ensure the padlocks are not left unlocked when the shackle is open.
- Both sides and front of the lock body can be laser engraved to retain permanent identification or coding.
- A variety of lock bodies and colors are available for your choosing.
- Can customize luminous PVC labels.

**Product Selection**

Part Code	Shackle (The first digit)		Lock Body		Lock Cylinder	Feature (optional)
	Material	Inner Height (mm)	Dia. (mm)	Color (The second digit)		
BD-G701	Stainless steel	38	4	EB type by default other 5 choices A,B,C, D,E.	Default Brass lock cylinder/ Non auto pop/With key retaining feature	DP (Base dustproof only)
BD-G711	Nylon	38			Optional Zinc lock cylinder Auto pop	
BD-G731	Nylon	20			Without key retaining feature	

Eg: Common padlock: BD-G701; Auto-popup padlock: BD-ZG701; Dust-proof padlock BD-G701-DP

**Product Appearance**

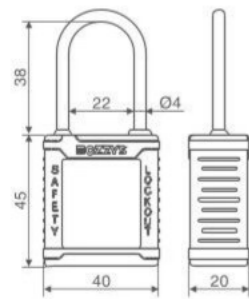

BD-G701/G711

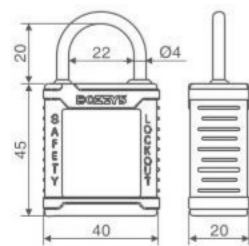

BD-G721

**BD-G800 SERIES  
 SAFETY PADLOCK  
 (LONG LOCK BODY TYPE)**



**Product Features**

- Made from engineering plastic reinforced nylon PA, Integrated housing design, more durable, withstand temperature from -20°C-+100C, shock resistance; the steel shackle is chrome plating. I the nylon shackle is made from DuPont nylon, ensure the strength and deformation fracture not easily.
- Contain "DANGER" and "PROPERTY OF" writable labels, Labels language can be customized.
- UV resistant and corrosion resistant, silicon free.
- Key retaining to ensure the padlocks are not left unlocked when the shackle is open.
- Both sides and front of the lock body can be laser engraved to retain permanent identification or coding.
- A variety of lock bodies and colors are available for your choosing.
- Can customize luminous PVC labels.

**Product Selection**

Part Code	Shackle (The first digit)			Lock Body		Lock Cylinder	Feature (optional)
	Material	Inner Height (mm)	Dia. (mm)	Lock Body	Color (The second digit)		
BD-G801	Steel/ Stainless steel	38	6.2	EB B	1: Red 2: Yellow 3: Blue 4: Green 5: Black 6: White 7: Orange 8: Purple	Default Zinc lock cylinder/ Non auto pop/With key retaining feature	DP
BD-G811	Nylon	38	6.2				
BD-G821	Steel	76	6.2				
BD-G831	Nylon	76	6.2			Optional Zinc lock cylinder/ Auto pop/Without key retaining feature	
BD-G841	Stainless Steel Cable	Cable length 150	3.2				

Eg: Common padlock: BD-G801; Stainless steel shackle safety padlock:BD-G801SI;Auto-popup padlock:BD-ZG801;Dust-proof padlock:BD-G801-DP;

**Product Appearance**

SAFETY PADLOCK

SAFETY PADLOCK



SAFETY PADLOCK

SAFETY PADLOCK

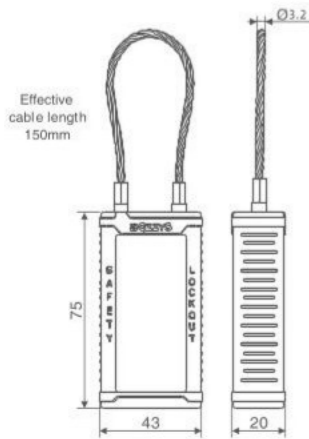
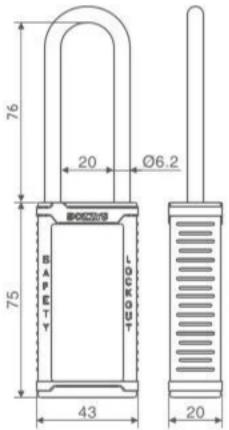
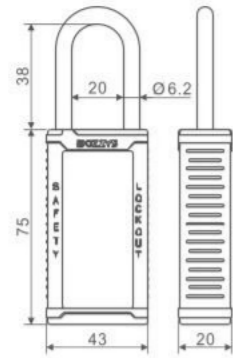

BD-G841

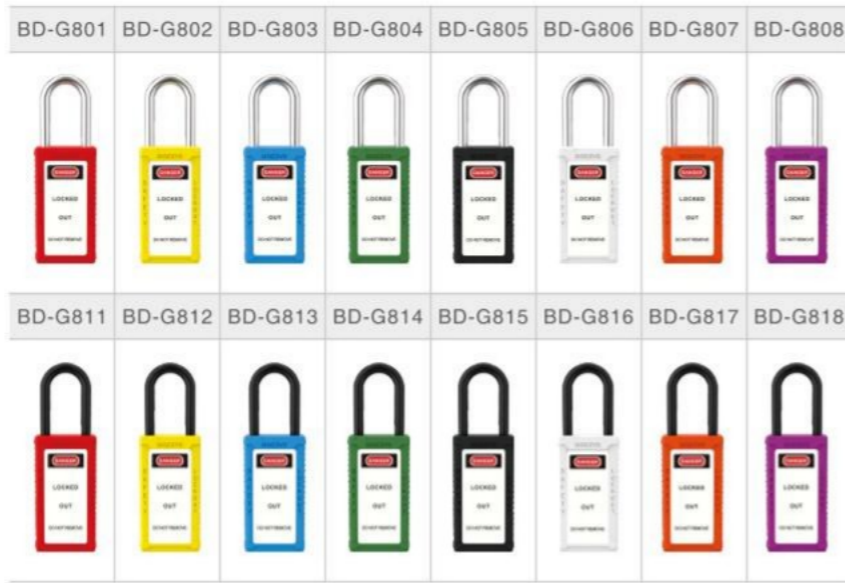

**BD-UG00 SERIES  
 SAFETY PADLOCK  
 (ULTRASONIC TYPE)**



**Ultrasonic Welding**

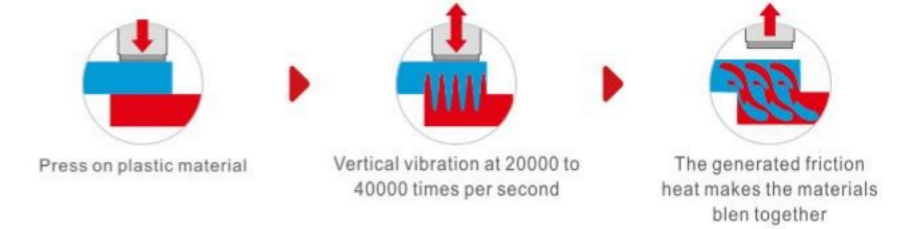

**Product Features**

- Made from PC+ABS, Integrated housing design, more durable, withstand temperature from -20°C~+100°C, shock resistance; the steel shackle is chrome plating; the nylon shackle is made from DuPont nylon, ensure the strength and deformation fracture not easily.
- Contain "DANGER" and "PROPERTY OF" writable labels, Labels language can be customized.
- UV resistant and corrosion resistant, silicon free.
- Key retaining to ensure the padlocks are not left unlocked when the shackle is open.
- Both sides and front of the lock body can be laser engraved to retain permanent identification or coding.
- Can customize luminous PVC labels.

**Product Selection**

Part Code	Shackle (The first digit)			Lock Body		Lock Cylinder
	Material	Inner Height (mm)	Dia. (mm)	Lock Body	Color (The second digit)	
BD-UG01	Steel/ Stainless steel	38	6.2	F	1:Red 2:Yellow 3:Blue 4: Green 5: Black 6: White 7:Orange 8:Purple	Zinc lock cylinder/ Non auto pop/ With key retaining feature
BD-UG11	Nylon					

Eg: Common padlock: BD-UG01; Stainless steel shackle safety padlock:BD-UG01S; Auto-popup padlock: BD-ZUG01;

**Product Appearance**

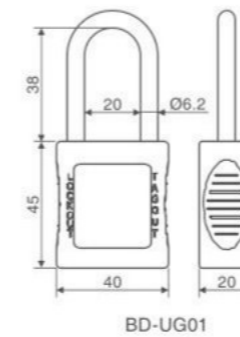

**BD-UG70 SERIES**  
**SAFETY PADLOCK**  
 (ULTRASONIC THIN SHACKLE TYPE)



**Ultrasonic Welding**

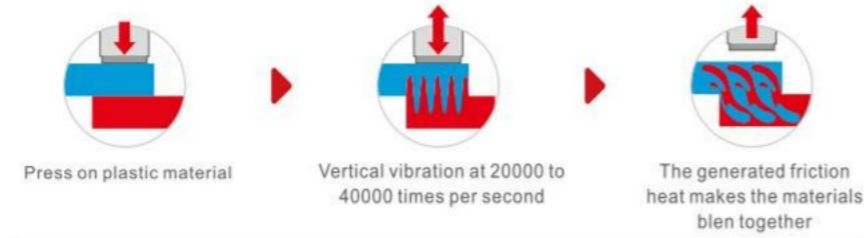

**Product Features**

- Made from PC+ABS, Integrated housing design, more durable, withstand temperature from -20°C~+100°C, shock resistance; the steel shackle is chrome plating; the nylon shackle is made from DuPont nylon, ensure the strength and deformation fracture not easily.
- Contain "DANGER" and "PROPERTY OF" writable labels, Labels language can be customized.
- UV resistant and corrosion resistant, silicon free.
- Key retaining to ensure the padlocks are not left unlocked when the shackle is open.
- Both sides and front of the lock body can be laser engraved to retain permanent identification or coding.
- Can customize luminous PVC labels.

**Product Selection**

Part Code	Shackle (The first digit)		Lock Body		Lock Cylinder (optional)
	Material	Inner Height (mm)	Dia. (mm)	Lock Body Color (The second digit)	
BD-UG71	Stainless steel	38	4	EB	Default Zinc lock cylinder/Non auto pop/ With key retaining feature  Optional Brass lock cylinder/ Non auto pop/With key retaining feature
BD-UG71N	Nylon	38			
BD-UG71ND	Nylon	20			

Eg: Common padlock: BD-UG71; Auto-popup padlock:BD-ZUG71; Dust-proof padlock:BD-UG71-DP;

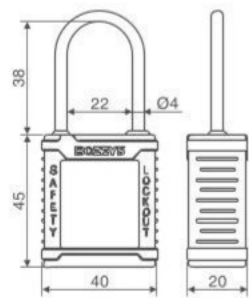

BD-UG71S/UG71N

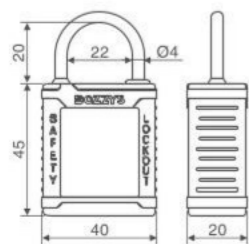

BD-UG71ND

**Product Appearance**

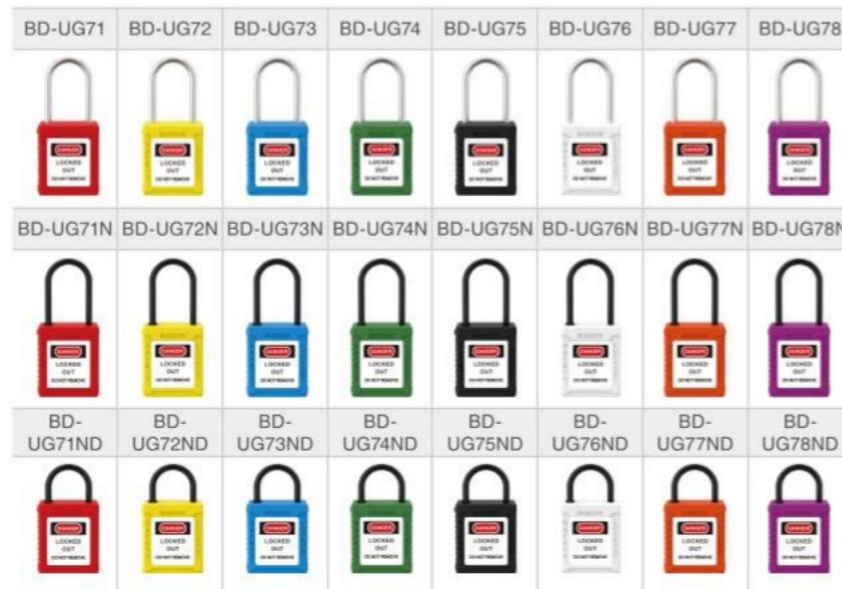

**BD-LG80**  
**CABLE SAFETY PADLOCK**



**Product Features**

- Lock body is made from PA66+20%GF, its cable is made from stainless steel with PVC outer layer.
- Technical parameter: pulling force 800N, temperature -20°C~100°C
- Brass lock cylinder, can realize multi-level management.
- Cable has two different types, full transparent and black translucent.
- Padlock and cable lockout integrated design, easy to use.
- Have appearance and structure patents.
- It can be used together with BD-P03 tag.
- Chinese and English labels (customizable).

**Product Selection**

Part Code	Cable			Lock Cylinder
	Material	Dia. (mm)	Cable length	
BD-LG80-3	Stainless steel +PVC coated	3	Stainless cable length: 0.8m, Other cable length can be customized	Brass lock cylinder
BD-LG80-4		4		

**Note:** The rope's diameter and length need to be noted.

**Product Appearance**



**BD-LG10**  
**CABLE LOCKOUT**



**Product Features**

- Outer shell: PA66+20%GF, embedded nickel-plated spring and copper lock wire actuator
- Secure the special-shaped valve in the closed position to prevent accidents
- Equipped with its own lock core, it replaces traditional locking methods, and installation is quick and easy.

**Product Selection**

Part Code	cable			Lock Cylinder
	Material	Dia. (mm)	Cable length (M)	
LG10	Stainless steel	1.5	Standard cable length: 0.5m, Other cable length can be customized	Brass lock cylinder

SAFETY PADLOCK

SAFETY PADLOCK

**BD-A20D SERIES**  
**ALUMINUM PADLOCK**



**Product Features**

- The lock body is processed and formed by aluminum alloy profiles machine, with anodized surface, bright color, and corrosion resistant metal lock shackle.
- Engrave LOGO, can customize customers's logo.
- UV resistant and corrosion resistant.
- Auto pop safety padlock: The lock shackle pops up automatically when unlocking, and the lock cylinder locks automatically when locking.
- Key retaining to ensure the padlocks are not left unlocked when the shackle is open.
- Both sides and front of the lock body can be laser engraved to retain permanent identification or coding
- Various colors for choosing.

**Product Selection**

Part Code	Shackle			Color (The second digit)	Lock Cylinder
	Material	Inner Height (mm)	Dia (mm)		
BD-A21D	Steel/ Stainless steel	38	6.2	Red	Brass lock cylinder/ Auto pop/ with key retaining feature
BD-A22D				Golden	
BD-A23D				Blue	
BD-A24D				Green	
BD-A25D				Black	
BD-A26D				Silver	
BD-A27D				Orange	
BD-A28D				Purple	

Note: The default is steel shackle, pls remark stainless steel shackle if need.

**Product Appearance**

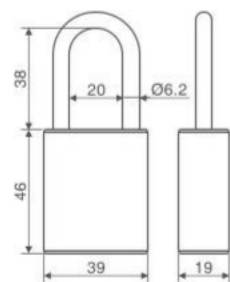

BD-A21D

**BD-A30 SERIES**  
**ALUMINUM PADLOCK**



**Product Features**

- The lock body is processed and formed by aluminum alloy profiles machine, with anodized surface, bright color, and corrosion resistant metal lock shackle.
- Engrave LOGO, can customize customers's logo.
- UV resistant and corrosion resistant.
- Auto pop safety padlock: The lock shackle pops up automatically when unlocking, and the lock cylinder locks automatically when locking.
- Key retaining to ensure the padlocks are not left unlocked when the shackle is open.
- Both sides and front of the lock body can be laser engraved to retain permanent identification or coding
- Various colors for choosing.

**Product Selection**

	Shackle			Color (The second digit)	Lock Cylinder
	Material	Inner Height (mm)	Dia (mm)		
BD-A31	Steel/ Stainless steel		6.2	Red	Brass lock cylinder/ Auto pop/ with key retaining feature
BD-A32				Golden	
BD-A33				Blue	
BD-A34				Green	
BD-A35				Black	
BD-A36				Silver	
BD-A37				Orange	
BD-A38				Purple	

Note: The default is steel shackle, pls remark stainless steel shackle if need.

**Product Appearance**

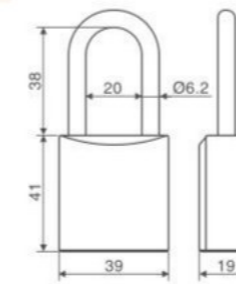

BD-A31



SAFETY PADLOCK

SAFETY PADLOCK

**BD-A40D SERIES  
 ALUMINUM PADLOCK**

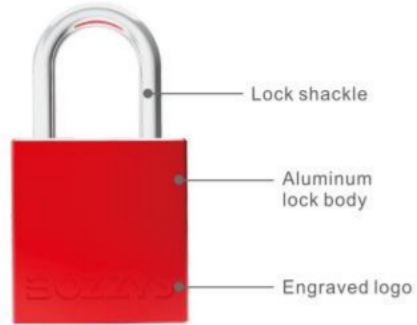

**Product Features**

- The lock body is processed and formed by aluminum alloy profiles machine, with anodized surface, bright color, and corrosion resistant metal lock shackle.
- Engrave LOGO, can customize customers's logo.
- UV resistant and corrosion resistant.
- Auto pop safety padlock: The lock shackle pops up automatically when unlocking, and the lock cylinder locks automatically when locking.
- Key retaining to ensure the padlocks are not left unlocked when the shackle is open.
- Both sides and front of the lock body can be laser engraved to retain permanent identification or coding
- Various colors for choosing.

**Product Selection**

Part Code	Shackle			Color (The second digit)	Lock Cylinder
	Material	Inner Height (mm)	Dia (mm)		
BD-A41D	Steel/ Stainless steel	25	4.7	Red	Brass lock cylinder/ Auto pop/ with key retaining feature
BD-A42D				Golden	
BD-A43D				Blue	
BD-A44D				Green	
BD-A45D				Black	
BD-A46D				Silver	
BD-A47D				Orange	
BD-A48D				Purple	

Note: The default is steel shackle, pls remark stainless steel shackle if need.

**Product Appearance**

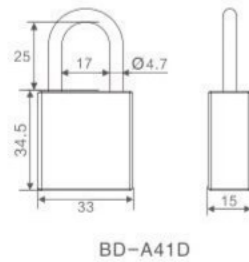

**BD-J10/20/30 SERIES  
 JACKET SAFETY PADLOCK**



**Product Features**

- Made of ABS(lock shell), mate(lock body inside), and chrome plated steel shackle.
- With rewritable "DANGER" and "PROPERTY OF" warning label (Other languages can be customized)
- UV and corrosion resistant
- Laser printing available, front or flanks.
- 8 colors available.

**Product Selection**

Part Code	Shackle			Color (The second digit)	Lock Cylinder
	Material	Inner Height (mm)	Dia (mm)		
BD-J11	Steel	24	6.2	1:Red 2:Yellow 3:Blue 4:Green 5:Black 6:White 7:Orange 8:Purple	Brass lock cylinder
BD-J21		36			
BD-J31		65			

**Product Appearance**

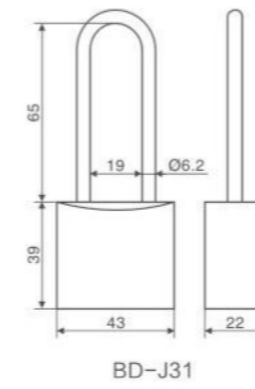
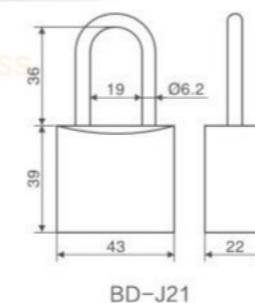
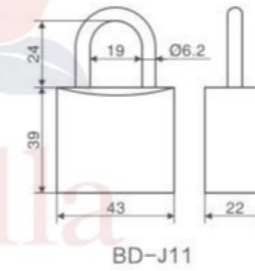

SAFETY PADLOCK

SAFETY PADLOCK

## BD-G01PRO Series Premium Padlock



### Product Features

- Durable material and robust structure: Lock body made of reinforced nylon PA engineering plastic, one-piece shell design for greatly improved durability; temperature resistance range -30°C to +120°C, excellent impact resistance. Metal shackle made of 304 stainless steel; insulated shackle made of 60% glass-fiber reinforced polyaramid for ultra-high strength.
- Superior tensile strength: In locked state, tensile load capacity meets standards; metal shackle: ≥2300N; insulated shackle: ≥1100N
- Self-ejecting padlock design: Shackle automatically pops out when unlocked, cylinder automatically drops when locked – convenient and worry-free operation.
- Key-retaining anti-theft design: Key-retaining function prevents padlock from being left on site in open state, eliminating safety hazards.
- Writable custom label: Standard with writable label printed with "DANGER" and "OWNER"; supports customization in Chinese and other languages.
- Laser engraving marking: Front of lock body supports laser engraving for permanent marking, coding, etc., resistant to wear and peeling.

### Product Selection

Part Code	Shackle			Color (The second digit)	Lock Cylinder
	Material	Inner Height (mm)	Dia (mm)		
BD-G01PRO	Steel/ Stainless steel	30.5	5.5	Red	Brass lock cylinder/ Auto pop/ with key retaining feature
BD-G02PRO				Golden	
BD-G03PRO				Blue	
BD-G04PRO				Green	
BD-G05PRO				Black	
BD-G06PRO				Silver	
BD-G07PRO				Orange	
BD-G08PRO				Purple	

### Product Appearance



### Overall Dimension

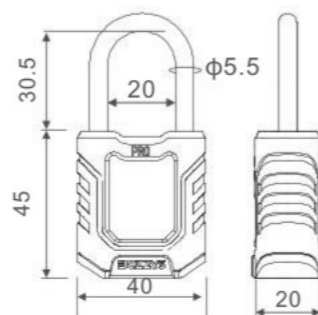

## BD-G11PRO Series Premium Padlock



### Product Features

- Durable material and robust structure: Lock body made of reinforced nylon PA engineering plastic, one-piece shell design for greatly improved durability; temperature resistance range -30°C to +120°C, excellent impact resistance. Metal shackle made of 304 stainless steel; insulated shackle made of 60% glass-fiber reinforced polyaramid for ultra-high strength.
- Superior tensile strength: In locked state, tensile load capacity meets standards; metal shackle: ≥2300N; insulated shackle: ≥1100N
- Self-ejecting padlock design: Shackle automatically pops out when unlocked, cylinder automatically drops when locked – convenient and worry-free operation.
- Key-retaining anti-theft design: Key-retaining function prevents padlock from being left on site in open state, eliminating safety hazards.
- Writable custom label: Standard with writable label printed with "DANGER" and "OWNER"; supports customization in Chinese and other languages.
- Laser engraving marking: Front of lock body supports laser engraving for permanent marking, coding, etc., resistant to wear and peeling.

### Product Selection

Part Code	Shackle			Color (The second digit)	Lock Cylinder
	Material	Inner Height (mm)	Dia (mm)		
BD-G11PRO	Nylon Shackle	30.5	5.5	Red	Brass lock cylinder/ Auto pop/ with key retaining feature
BD-G12PRO				Golden	
BD-G13PRO				Blue	
BD-G14PRO				Green	
BD-G15PRO				Black	
BD-G16PRO				Silver	
BD-G17PRO				Orange	
BD-G18PRO				Purple	

### Product Appearance



### Overall Dimension

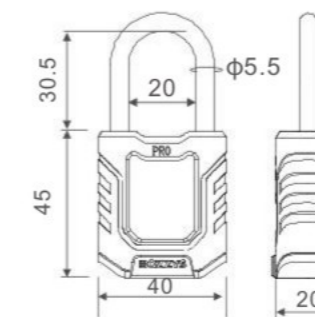

## BD-G601 Series Hasp Padlock



### Product Features

- Integrates padlock and hasp functions; housing: ultrasonic welding; cylinder made of brass.
- The lock body is reserved with three  $\Phi 7$ mm shared locking holes, which facilitates secondary inspection, maintenance, and re-locking after the initial lockout/tagout has been applied.
- Self-ejecting padlock design: the shackle automatically pops out when unlocked, and the cylinder automatically locks when closed, making operation convenient and hassle-free.
- Writable custom label: Standard with writable label printed with "DANGER" and "OWNER"; supports customization in Chinese and other languages.
- Laser engraving marking: Front of lock body supports laser engraving for permanent marking, coding, etc., resistant to wear and peeling.

### Product Selection

Part Code	Shackle			Color (The second digit)	Lock Cylinder
	Material	Inner Height (mm)	Dia (mm)		
BD-G601	Steel/ Stainless steel	29.8	5.5	Red	Brass lock cylinder/ Auto pop/ with key retaining feature
BD-G602				Golden	
BD-G603				Blue	
BD-G604				Green	
BD-G605				Black	
BD-G606				Silver	
BD-G607				Orange	
BD-G608				Purple	

### Product Appearance



### Overall Dimension

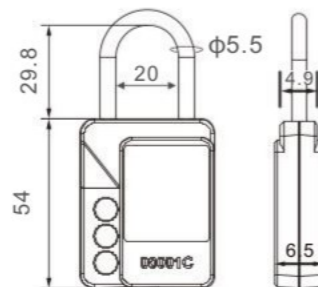

## BD-G611 Series Hasp Padlock



### Product Features

- Integrates padlock and hasp functions; housing: ultrasonic welding; cylinder made of brass.
- The lock body is reserved with three  $\Phi 7$ mm shared locking holes, which facilitates secondary inspection, maintenance, and re-locking after the initial lockout/tagout has been applied.
- Self-ejecting padlock design: the shackle automatically pops out when unlocked, and the cylinder automatically locks when closed, making operation convenient and hassle-free.
- Writable custom label: Standard with writable label printed with "DANGER" and "OWNER"; supports customization in Chinese and other languages.
- Laser engraving marking: Front of lock body supports laser engraving for permanent marking, coding, etc., resistant to wear and peeling.

### Product Selection

Part Code	Shackle			Color (The second digit)	Lock Cylinder
	Material	Inner Height (mm)	Dia (mm)		
BD-G611	Nylon Shackle	29.8	5.5	Red	Brass lock cylinder/ Auto pop/ with key retaining feature
BD-G612				Golden	
BD-G613				Blue	
BD-G614				Green	
BD-G615				Black	
BD-G616				Silver	
BD-G617				Orange	
BD-G618				Purple	

### Product Appearance



### Overall Dimension

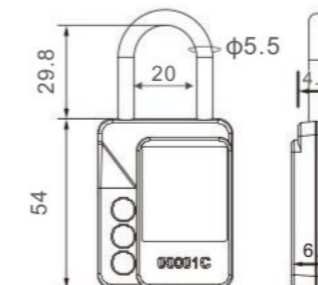

SAFETY PADLOCK

SAFETY PADLOCK



**BD-J40 SERIES**  
**LAMINATED PADLOCK**



**Product Features**

- Made of multi-layer high strength metal steel sheets which surface use zinc plating process, and steel shackle.
- With rewritable "DANGER" and "PROPERTY OF" warning label (Other languages can be customized)
- Suitable for special environment and condition.

**Product Selection**

Part Code	Shackle			Lock Body			Lock Cylinder		
	Material	Inner Height A(mm)	Inner Width B(mm)	Dia C(mm)	Material	Inner Width W(mm)		Inner Width H(mm)	Dia D(mm)
BD-J41	Steel	18	14	5	Steel	33	27	20	Iron Cylinder
BD-J42		24	20	6		43	34	25	
BD-J43		46	20	6		43	34	25	
BD-J44		25	21	7		48	34	26	
BD-J45		30	24	8.7		53	37	29	
BD-J46		61	24	8.7		53	39	29	

**Overall Dimensions**

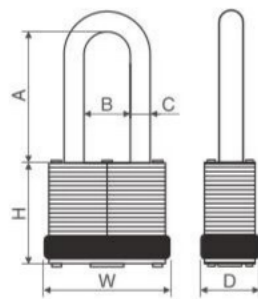

**BD-J47/J48**  
**LAMINATED PADLOCK**

Unit: mm



**Product Features**

- Made of multi-layer high strength metal steel sheets which surface use zinc plating process, and steel shackle.
- UV and corrosion resistant.
- Suitable for special environment and condition.

**Product Appearance**

Part Code	Shackle			Lock Cylinder			Lock Cylinder		
	Material	Inner Height (mm)	Inner Width (mm)	Shackle Dim.	Material	Height (mm)		Width (mm)	Thickness (mm)
BD-J47	Steel	56.5	19.5	6.2	Steel	31.5	43.7	26	Iron Cylinder
BD-J48		31	24.8	8.2		41.5	53	29	

**BD-LG90**  
**ADJUSTABLE CABLE PADLOCK**

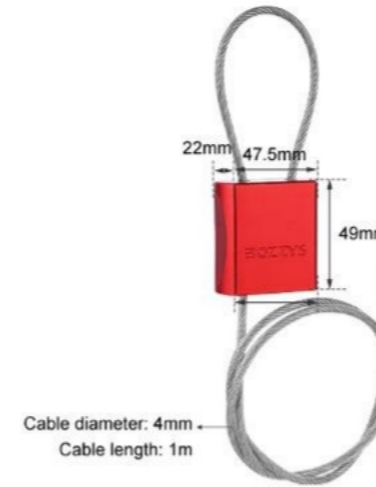

**Product Features**

- Lock Shell: Aluminum Cable: Stainless Steel + PVC ; Lock Cylinder: Brass
- Cable: Diameter: 4mm, Length: 1m (Customizable)
- UV and corrosion resistant
- Color: Red (Customizable color, default is red)
- Describe: Integrated Cable and Padlock Function

**Product Selection**

Part Code	Cable			Lock Cylinder
	Material	Dia. (mm)	Cable length	
BD-LG90	Stainless steel +PVC coated	4	Stainless cable length: 0.8m, Other cable length can be customized	Brass lock cylinder

**Note:** The rope's diameter and length need to be noted.



# TAGS & SPECIAL PEN

## LOCKOUT TAGOUT

### Product Introduction

- Lockout tagout can be used to make a holistic control of the equipment to protect workers from accident and equipment from damage.
- Use with safety padlock to remind that the equipment has been locked and can not be operated. It can only be opened by the one who lock it. It enables people to know who has locked it, thereby knowing that operating the equipment is dangerous.
- You can see "Danger/Do not operate/ Caution" etc warnings on the tag and also "Name/department/Date" etc blank for you to fill in.
- Offer language customization.

### Product Features

- Polyvinyl chloride (PVC) tag resistant to common industrial chemicals, plastic sealing PET coated tag can prevent grease and dust.
- A tag with the "DO NOT OPERATE" message.
- According to the employee's name, unit, telephone number, etc., for employees to identify.
- Set with 10mm Dia. yellow buttonholes suitable for all types of padlocks and resistant to pressure.



### Customization

#### Customization



- Material: PVC, no-easy tear paper, stainless steel sheet and doon.
- Thickness: 0.3-2.5mm.
- Size: any size.
- Printing requirements: whether plastic coated or not, individual set type, UV rays resistance printing, individual personal photo input and soon.

## CUSTOMIZED HANG TAG



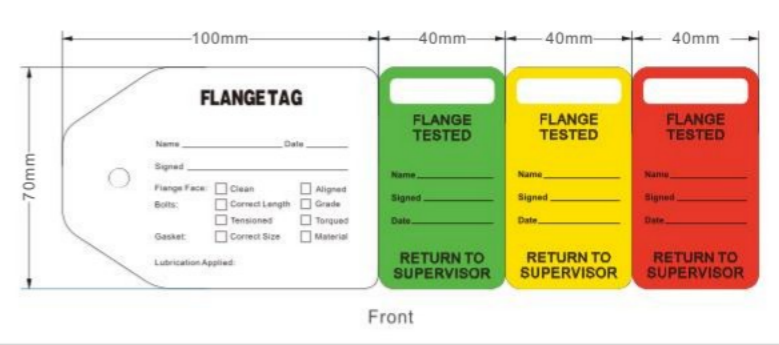

Display			
	Front Back	Front Back	Front Back
Model	BD-P01	BD-P02	BD-P02A
Material	PVC	PVC	PVC with plastic sealed
Thickness	0.4mm	0.3mm	0.55mm

Display		
	Front Back	Front
Model	PT1-P31	PT1-P41
Material	PVC	PVC
Thickness	0.4mm	0.4mm

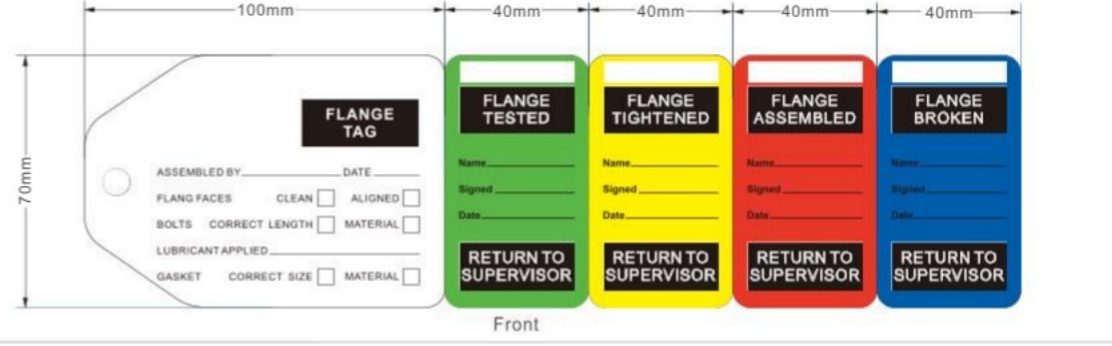
Display			
	Front Back	Front Back	Front Back
Model	BD-P03	BD-P04	BD-P05
Material	PET	PVC	PVC
Thickness	0.3mm	0.4mm	0.4mm

Display	
	Front
Model	PT1-P51
Material	PVC
Thickness	0.4mm

Display			Model	Material	Colour
	Front Back	Front Back	BD-P11		Red
Model	BD-P06		BD-P12		Golden
Material	PVC with plastic sealed		BD-P13	PVC	Blue
Thickness	0.55mm		BD-P14		Green
			BD-P15		Black

**STR021/STR022/STR001 COILED SAFETY TAG**



**Product Features**

- Hang Tag Material: Utilizes PP Composite Paper With a density less than 0.8g/cm<sup>3</sup>, it offers excellent lightness and rigidity. It is durable and features high strength, puncture resistance, tear resistance (especially in the crosswise direction), abrasion resistance, and fold endurance. Additionally, it is waterproof and moisture-proof.

**Product Selection**

Model	Description	Application
STR001	The S-Roll Hang Tag is a long, strip-shaped, and roll-up type of hang tag. It allows for multiple hang tag contents to be arranged continuously. When not in use, it occupies minimal space and is convenient to tear off and use one by one, making it easy to access and use as needed.	

**SCAFFOLDING TAG**

**Product Introduction**

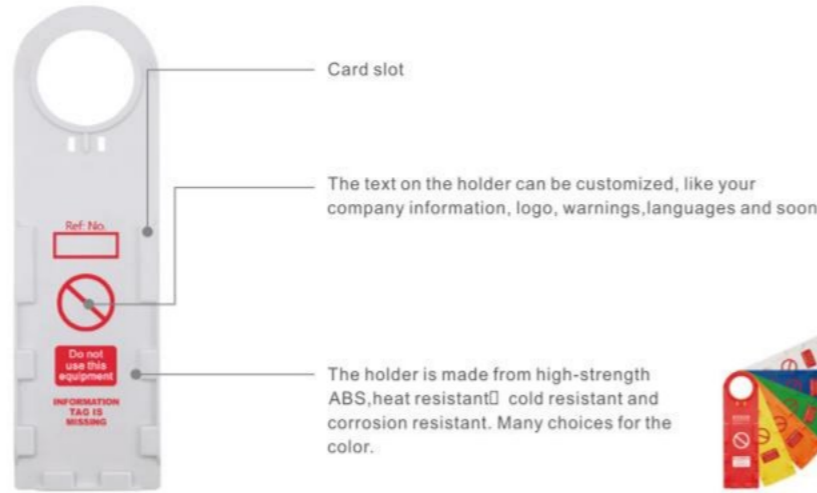

**BD-P32  
 MULTIFUNCTIONAL  
 SCAFFOLDING TAG**

Thickness: 6mm



Scaffolding Holder	Tag	Customization

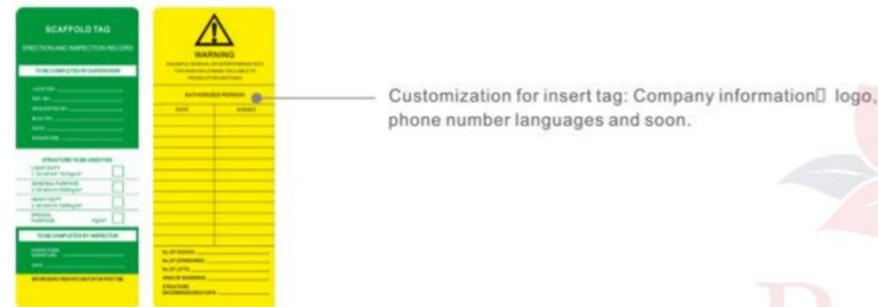

**BD-P33  
 CIRCULAR TYPE  
 MULTIFUNCTIONAL  
 SCAFFOLDING TAG**

Thickness: 6mm  
 Weight: 75g



Scaffolding Holder	Tag	Customization

Category	Description
SCAFFOLDING HOLDER	Tags can be stuck on the equipment or tied to the wire.
TAG	Green card: scaffold is safe, can be used normally. Yellow card: scaffold is breakdown, in the maintenance. Red card (no card): scaffold is for forbidden to use.

**BD-P31  
 SMALL  
 MULTIFUNCTIONAL  
 SCAFFOLDING TAG**



**Description**

Scaffolding Holder	Tag	Customization

**BD-P34  
 LARGE  
 MULTIFUNCTIONAL  
 SCAFFOLDING TAG**

Thickness: 6mm  
 Weight: 88g



Scaffolding Holder	Tag	Customization

**BD-P35**  
**HOOK TYPE**  
**MULTIFUNCTIONAL**  
**SCAFFOLDING TAG**

Thickness: 6mm  
 Weight: 88g



Scaffolding Holder	Tag	Customization

**BD-P39**  
**CIRCULAR TYPE**  
**MULTIFUNCTIONAL**  
**SCAFFOLDING TAG**

Thickness: 6mm

Scaffolding Holder	Tag	Customization

**BD-P36**  
**MULTIFUNCTIONAL**  
**SCAFFOLDING TAG**

Thickness: 6mm  
 Weight: 110g



Scaffolding Holder	Tag	Customization

**BD-P40**  
**MULTIFUNCTIONAL**  
**SCAFFOLDING TAG**

Thickness: 7mm

Scaffolding Holder	Tag	Customization

**BD-P37**  
**MULTIFUNCTIONAL**  
**SCAFFOLDING TAG**

Thickness: 6.5mm

Scaffolding Holder	Tag	Customization

**BD-P38**  
**CIRCULAR TYPE**  
**MULTIFUNCTIONAL**  
**SCAFFOLDING TAG**

Thickness: 6.7mm  
 Weight: 62.2g

Scaffolding Holder	Tag	Customization

**Application**

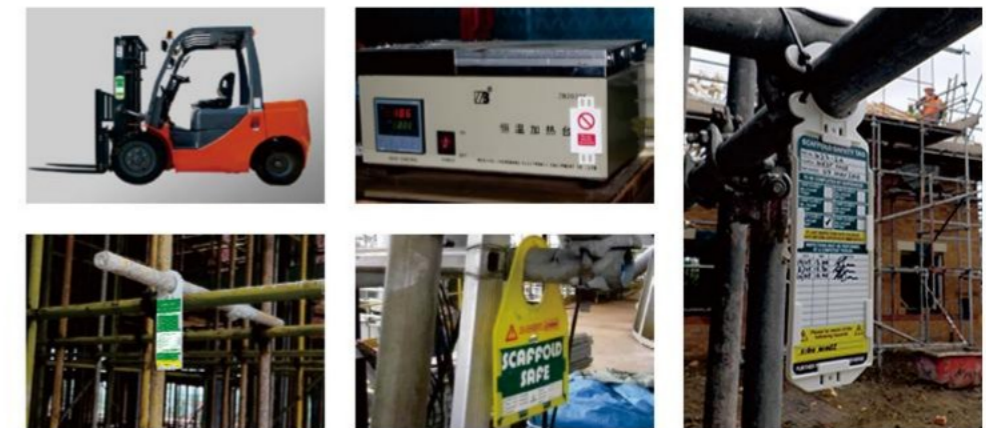

# SAFETY HASP



## BD-K01/K02 PA COATED STEEL HASP

Unit:mm

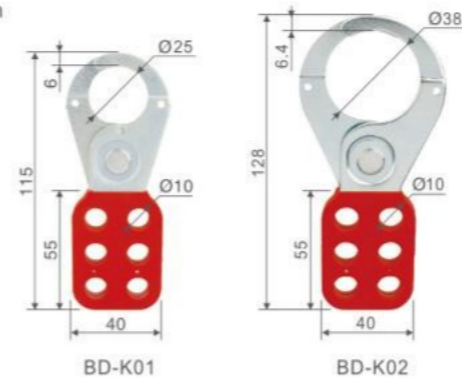

## BD-K03/K04 ECONOMIC STEEL HASP

Unit:mm

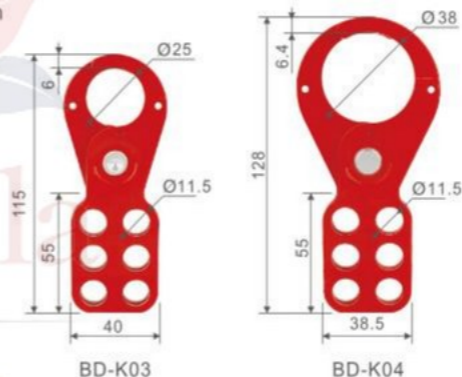

## BD-K05 HIGH STRENGTH STEEL HASP

Unit:mm

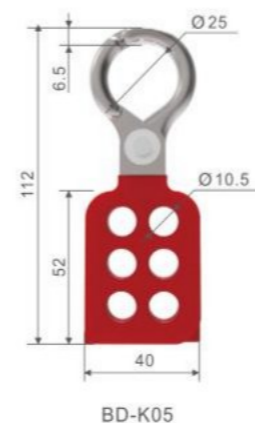

### Product Features

- Made of Engineering plastic nylon PA injection molding, galvanized rustproof surface.

### Description

Model	Lock hole Dia.	Lock shackle Dia.	Description
BD-K01	10.5mm(2/5")	25mm(1")	Can be accommodated with 6 padlocks(maximum)
BD-K02	10.5mm(2/5")	38mm(1.5")	

### Product Features

- Made of high temperature plastic sprayed steel.

### Description

Model	Lock hole Dia.	Lock shackle Dia.	Description
BD-K03	10.5mm(2/5")	25mm(1")	Can be accommodated with 6 padlocks(maximum)
BD-K04	10.5mm(2/5")	38mm(1.5")	

### Product Features

- Made of zinc plated steel and PVC dipping handle.

### Product Selection

Model	Lock hole Dia.	Lock shackle Dia.	Description
BD-K05	10.5mm(2/5")	25mm(1")	Can be accommodated with 6 padlocks(maximum)

**BD-K11/K12**  
 SPARK-PROOF ALUMINUM HASP

Unit:mm

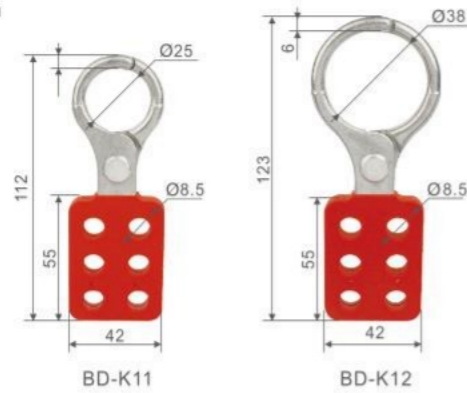

**Product Features**

- Made of chrome plated aluminum and nylon PA injection molding or PVC dipping handle.

**Description**

Model	Lock hole Dia.	Lock shackle Dia.	Description
BD-K11	9mm(9/25")	25mm(1")	Can be accommodated with 6 padlocks(maximum)
BD-K12	9mm(9/25")	38mm(1.5")	

**BD-K23/K24**

Unit:mm

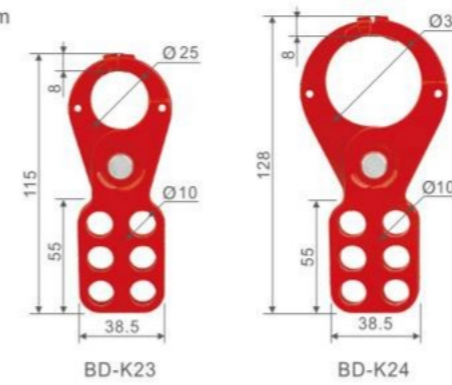

**Product Features**

- Made of high temperature plastic sprayed steel.
- The ring hook is designed to prevent being pried off.

Model	Lock hole Dia.	Lock shackle Dia.	Description
BD-K23	10.5mm(2/5")	25mm(1")	Can be accommodated with 6 padlocks(maximum)
BD-K24	10.5mm(2/5")	38mm(1.5")	

**BD-K13/K14**  
 SPARK-PROOF ZINC ALLOY HASP

Unit:mm

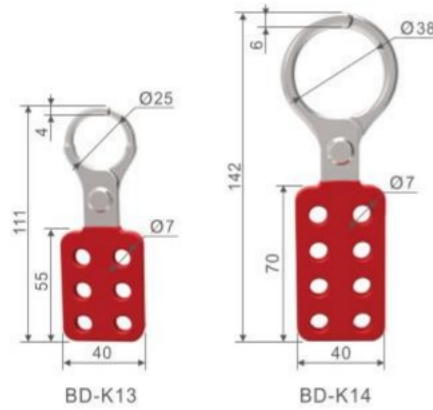

**Product Features**

- Made of chrome plated zinc alloy and nylon PA or TPE injection molding handle.

**Description**

Model	Lock hole Dia.	Lock shackle Dia.	Description
BD-K13	7mm(7/25")	25mm(1")	Can be accommodated with 6 padlocks(maximum)
BD-K14	7mm(7/25")	38mm(1.5")	Can be accommodated with 8 padlocks(maximum)

**BD-K31S-1/K31S-2**  
 BUTTERFLY LOCKOUT HASP

Unit:mm

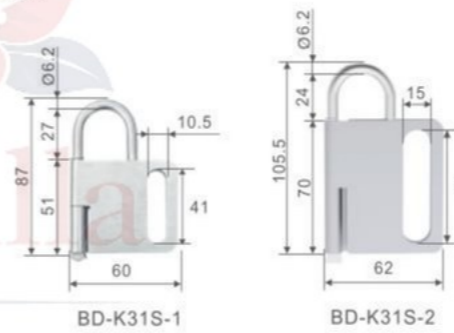

**Product Features**

- K31S-1/K31S-2 is made of 304 stainless steel.
- Sturdy and durable.

**Description**

Model	Shackle Dia.	Shackle inner height	Description
BD-K31S-1	6.2mm	27mm	Can be accommodated with 6 padlocks(maximum)
BD-K31S-2	6.2mm	24mm	Can be accommodated with 8 padlocks(maximum)

**BD-K21/K22**  
 STEEL HASP WITH HOOK

Unit:mm

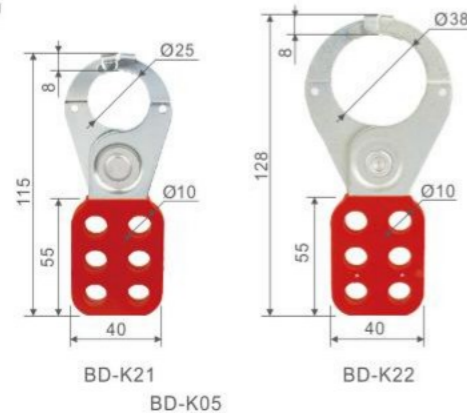

**Product Features**

- Made of chrome plated or zinc plated steel and nylon PA injection molding or PVC dipping handle.
- The ring hook is designed to prevent being pried off.

**Description**

Model	Lock hole Dia.	Lock shackle Dia.	Description
BD-K21	10.5mm(2/5")	25mm(1")	Can be accommodated with 6 padlocks(maximum)
BD-K22	10.5mm(2/5")	38mm(1.5")	

**BD-K32S**  
 BUTTERFLY LOCKOUT HASP

Unit:mm

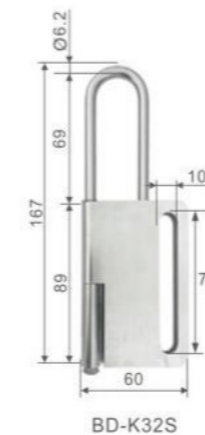

**Product Features**

- K32S is made of 304 stainless steel.
- Sturdy and durable.

**Description**

Model	Shackle Dia.	Shackle inner	Description
BD-K32S	6.2mm	69mm	Can be accommodated with 10 padlocks(maximum)

SAFETY HASP

SAFETY HASP

**BD-K33/K33X**  
**STAINLESS STEEL BUTTERFLY**  
**LOCKOUT HASP**

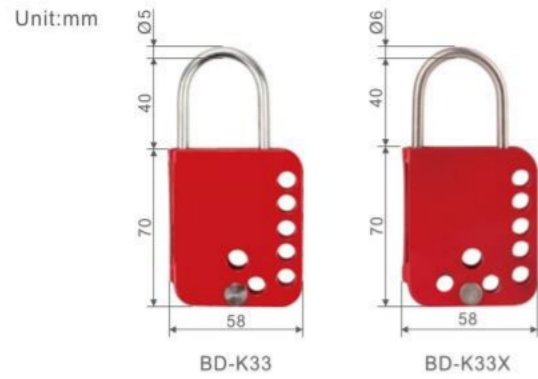

**Product Features**

- Made of high temperature plastic sprayed 304 stainless steel.
- Sturdy and durable.

**Description**

Model	Shackle Dia.	Shackle inner height	Description
BD-K33	5mm	40mm	Can be accommodated with 7 padlocks(maximum)
BD-K33X	6mm	40mm	Can be accommodated with 8 padlocks(maximum)

**BD-K34**  
**BUTTERFLY LOCKOUT HASP**



**Product Features**

- Made of ABS and 304 stainless steel.

**Description**

Model	Shackle Dia.	Shackle inner height	Description
BD-K34	4mm	27mm	Can be accommodated with 2 padlocks(maximum)

**BD-K35S**  
**STAINLESS STEEL BUTTERFLY**  
**LOCKOUT HASP**

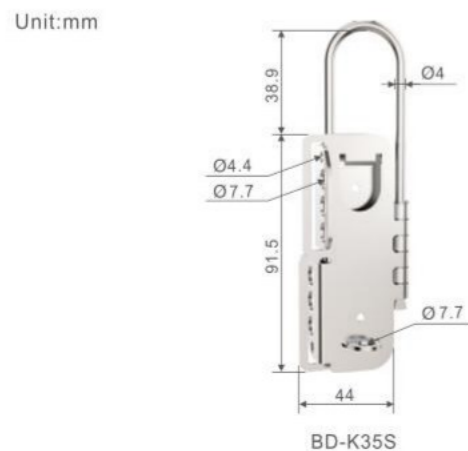

**Product Features**

- Made of 314 stainless steel.
- Sturdy and durable.

**Description**

Model	Shackle Dia.	Shackle inner height	Description
BD-K35S	4mm	38mm	Can be accommodated with 10 padlocks(maximum)

**BD-K41/K42**  
**NYLON LOCKOUT HASP**

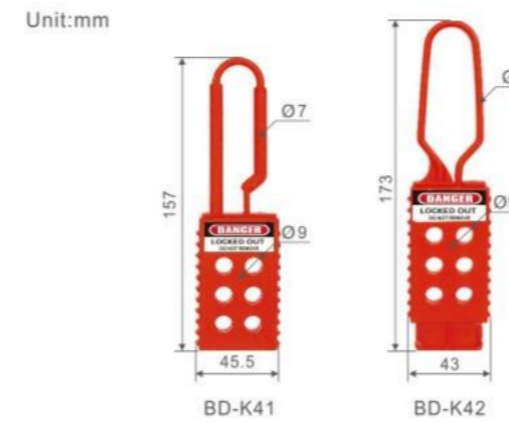

**Product Features**

- Made from modified PP.
- Apply to places where need electric power isolation and lock and has high requires about corrosive and explosion-proof.
- Opening: push up and down.

**Description**

Model	Shackle Dia.	Description
BD-K41	7mm	Can be accommodated with 6 padlocks(maximum)
BD-K42	6mm	

**BD-K43/K44**  
**NYLON LOCKOUT HASP**

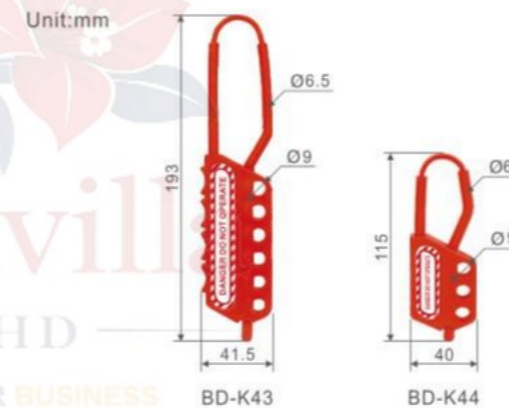

**Product Features**

- Made from modified PP.
- Apply to places where need electric power isolation and lock and has high requires about corrosive and explosion-proof.
- Side opening.

**Description**

Model	Shackle Dia.	Description
BD-K43	6.5mm	Can be accommodated with 6 padlocks(maximum)
BD-K44	6.5mm	Can be accommodated with 3 padlocks(maximum)

**BD-K45/K46**  
**NYLON LOCKOUT HASP**



**Product Features**

- The lock beam is made of American Dupont, and the lock body is made of alloy engineering plastic.
- Apply to places where need electric power isolation and lock and has high requires about corrosive and explosion-proof.

**Description**

Model	Shackle Dia.	Description
BD-K45	3mm	Can be accommodated with 4 padlocks(maximum)
BD-K46	6mm	

**BD-K51/K51S  
 LOCKOUT HASP**

Unit:mm



**Product Features**

- K51 Body is made of steel , hasp beam is made of aluminum.
- K51S Made of 304 stainless steel.
- strong and durable.

**Description**

Model	Shackle Dia.	Description
BD-K51	5mm	Can be accommodated with 6 padlocks(maximum)
BD-K51S	5mm	

**BD-K52/K53  
 ALUMINUM LOCKOUT HASP**

Unit:mm



**Product Features**

- Hasps are made of super strong oxidized aluminum alloy.
- The combination of label and hasp together
- resistant design of the tag applicable to a variety of environments
- Labels can be write on with pens.

**Description**

Model	Description	Color
BD-K52	Can be accommodated with 9 padlocks(maximum)	can be customized
BD-K53	Can be accommodated with 6 padlocks(maximum)	

**BD-K54  
 ALUMINUM LOCKOUT HASP**

Unit: mm



**Product Features**

- Hasps are made of super strong oxidized aluminum alloy.
- The combination of label and hasp together
- improves the applicability of the product itself, but also makes the heat-resistant design of the tag applicable to a variety of environments
- Labels can be write on with pens.

**Description**

Model	Description	Color
BD-K54	Can be accommodated with 5 padlocks(maximum)	can be customized

**BD-K61  
 DOUBLE-END ALUMINUM HASP**

Unit:mm

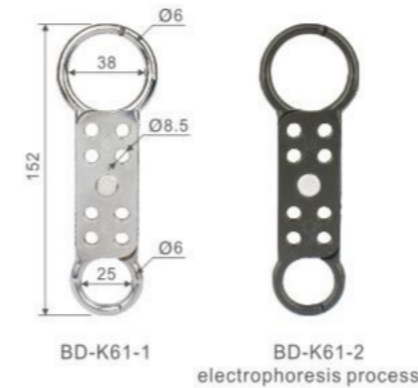

**Product Features**

- High fire-resisant aluminum alloy.
- Or anti-oxidation treated by high-temperature surge anti rust treatment.
- Double ends are different sizes,two functions.

**Description**

Model	Shackle Dia.	Description
BD-K61-1	6mm	Can be accommodated with 8 padlocks(maximum)
BD-K61-2	6mm	Can be accommodated with 8 padlocks(maximum)

**BD-K62  
 DOUBLE-END STEEL HASP**

Unit:mm

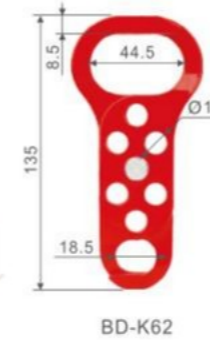

**Product Features**

- Lock body material: high strength steel.
- Surface:Anti-rust galvanized treatment under-high temperature.
- Hooks in two ends are different, having double functions.

**Description**

Model	Description
BD-K62	Can be accommodated with 6 padlocks (maximum)

**BD-K71/K72/K73  
 ALUMINUM BUCKLE LOCK**

Unit:mm

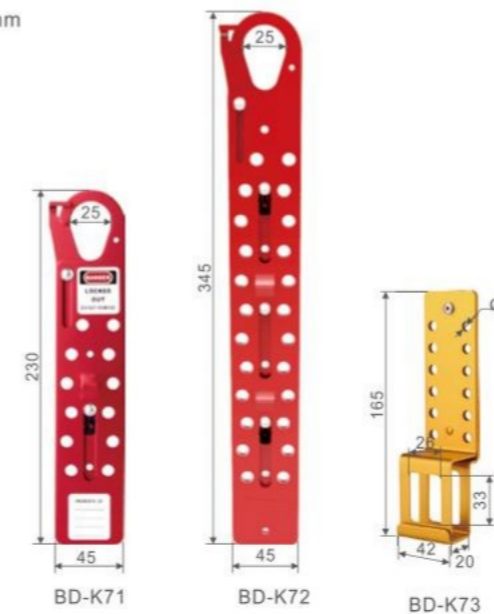

**Product Features**

- Made from aluminum alloy.
- Lock hole Dia.7mm or 8mm.
- Suitable for multi-person lock management.

**Description**

Model	Description
BD-K71	Can be accommodated with 12 padlocks (maximum)
BD-K72	Can be accommodated with 24 padlocks (maximum)
BD-K73	Can be accommodated with 12 padlocks (maximum)

SAFETY HASP

SAFETY HASP

**BD-K03A/K03B  
 LOCKOUT HASP**

Unit:mm

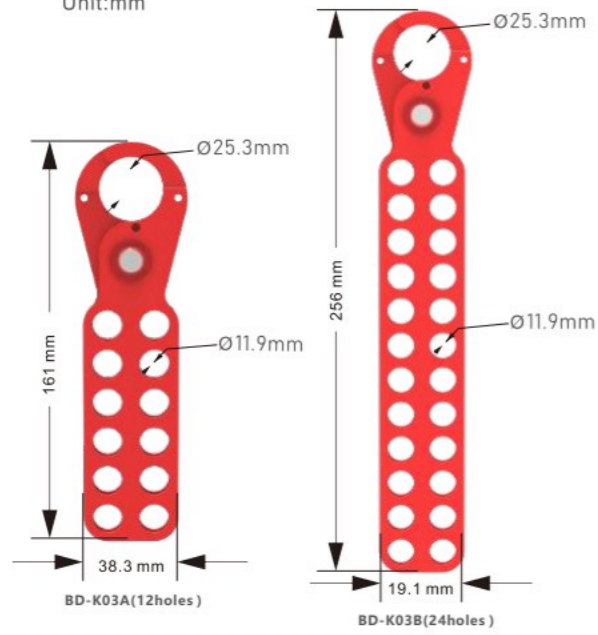

**Product Features**

- Made of steel, with high temperature spray coating treatment.
- Lock hole Dia:2/5

**Description**

Model	Description
BD-K03A	Lock shackle Dia. 1" (25mm), Can be accommodated with 12 padlocks (maximum)
BD-K03B	Lock shackle Dia. 1" (25mm), Can be accommodated with 24 padlocks (maximum)

SAFETY HASP



**ELECTRICAL LOCKOUT**



**BD-D01~D04**  
**MINIATURE CIRCUIT**  
**BREAKER LOCKOUT**

Unit: mm

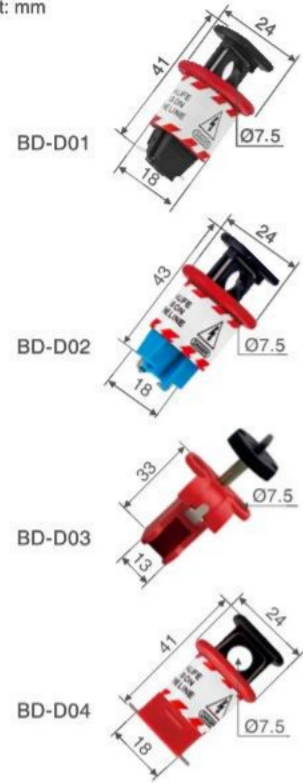

**Product Features**

- Made from engineering plastic strengthened nylon PA.
- Fit most existing types of European and Asia Circuit Breaker.
- Easily installed with the aid a push button or rotate roller.
- Available for single and multi-pole circuit breaker.
- Recommended to use in combination with a padlock for added safety.
- Can use padlocks with a shackle Dia. up to 7mm.
- The screws and pins are made of stainless steel.

**Product Selection**

Model	Description	Application
BD-D01	POS(Pin Out Standard),hole spacing≤12mm	
BD-D02	PIS(Pin In Standard),hole spacing≤12mm	
BD-D03	TBLO(Tie Bar Lockout)	
BD-D04	POW(Pin Out Wide),hole spacing≤20mm	

**BD-D05 SERIES**  
**SIMPLE CIRCUIT BREAKER**  
**LOCKOUT**

Unit: mm

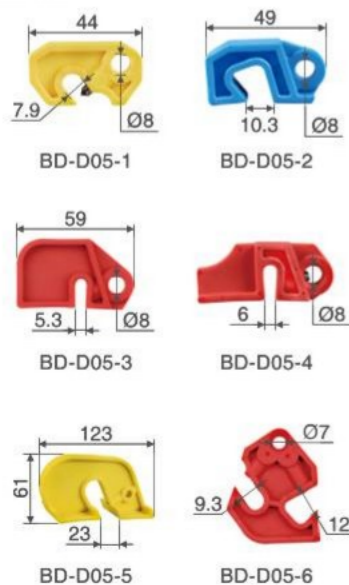

**Product Features**

- Made from rugged reinforced PA.
- Can lock it with screw diver.
- Can accommodate one safety padlock with shackle Dia.7mm
- Can lock all kinds of circuit breakers.

**Product Selection**

Model	Description	Application
BD-D05-1	Suitable for single pole miniature circuit breakers with handle width≤7.7mm	
BD-D05-2	Suitable for 2 to 4 poles miniature circuit breakers	
BD-D05-3	Suitable for mini and middle size circuit breakers with handle width≤5mm	
BD-D05-4	Suitable for mini and middle size circuit breakers with handle width≤5mm	
BD-D05-5	Suitable for large size circuit breakers	
BD-D05-6	Suitable for mini size circuit breakers with handle with ≤9.3mm middle size circuit breakers with handle width≤12mm	

**BD-D01~D04**  
**MINIATURE CIRCUIT**  
**BREAKER LOCKOUT**

Unit: mm

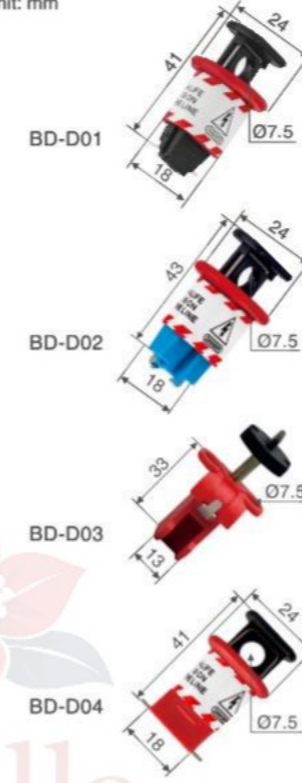

**Product Features**

- Made from engineering plastic strengthened nylon PA.
- Fit most existing types of European and Asia Circuit Breaker.
- Easily installed with the aid a push button or rotate roller.
- Available for single and multi-pole circuit breaker.
- Recommended to use in combination with a padlock for added safety.
- Can use padlocks with a shackle Dia. up to 7mm.
- The screws and pins are made of stainless steel.

**Product Selection**

Model	Description	Application
BD-D01	POS(Pin Out Standard),hole spacing≤12mm	
BD-D02	PIS(Pin In Standard),hole spacing≤12mm	
BD-D03	TBLO(Tie Bar Lockout)	
BD-D04	POW(Pin Out Wide),hole spacing≤20mm	

**BD-D05 SERIES**  
**SIMPLE CIRCUIT BREAKER**  
**LOCKOUT**

Unit: mm



**Product Features**

- Made from rugged reinforced PA.
- Can lock it with screw diver.
- Can accommodate one safety padlock with shackle Dia.7mm
- Can lock all kinds of circuit breakers.

**Product Selection**

Model	Description	Application
BD-D05-1	Suitable for single pole miniature circuit breakers with handle width≤7.7mm	
BD-D05-2	Suitable for 2 to 4 poles miniature circuit breakers	
BD-D05-3	Suitable for mini and middle size circuit breakers with handle width≤5mm	
BD-D05-4	Suitable for mini and middle size circuit breakers with handle width≤5mm	
BD-D05-5	Suitable for large size circuit breakers	
BD-D05-6	Suitable for mini size circuit breakers with handle with ≤9.3mm middle size circuit breakers with handle width≤12mm	

**BD-D06~D09**  
**SNAP-ON BREAKER LOCKOUT**



**Product Features**

- Made from engineering plastic reinforced nylon PA.
- Easy using-snap in right position, it is locked.
- Suitable for seldom miniature circuit breaker with the special handle. (as picture)

**Product Selection**

Model	BD-D06	BD-D07	BD-D08	BD-D09
Description	Suitable for very few small electrical appliances with special handles (refer to application scenario diagram)			
Application				

**BD-D11~D13**  
**BD-D11X~D13X**  
**CLAMP-ON BREAKER LOCKOUT**

Unit: mm



**Product Features**

- The base is made of PA66+20%GF, D11/D12/D13 lock body is made of modified PP, D11X/D12X/D13X lock body is made of PA+ABS.
- circuit breakers.
- to prevent clamp from being loosened.
- New blade design provides tighter grip with less torque on thumb screw.
- Detachable cleats expand the range of application breakers.
- The lockouts can take padlocks with a shackle Dia. up to 7mm.
- The base can clamp the bottom of the lock body very easily.
- Long sliding splint ensures locking of the circuit breaker.
- Compared with the old models, the new one is not easy to be broken.

**Product Selection**

Model	Description	Application
BD-D11	Maximum locking range handle width 16mm, thickness 10mm	
BD-D11X		
BD-D12	Maximum locking range handle width 38mm, thickness 13mm	
BD-D12X		
BD-D13	Maximum locking range handle width 68mm, thickness 22mm	
BD-D13X		

**BD-D10-1**  
**SIMPLE CIRCUIT BREAKER LOCKOUT**

Unit: mm

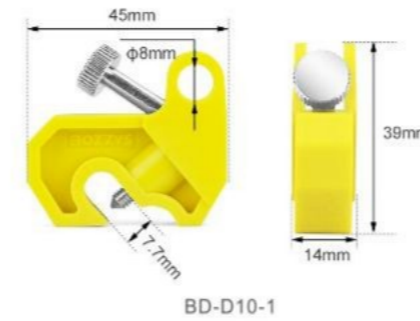

**Product Features**

- Made from durable reinforced nylon.
- Keyhole diameter: 8mm.
- Comes with locking screws, easy to lock without tools.

**Product Selection**

Model	Description	Application
BD-D10-1	Suitable for small and medium-sized plastic case circuit breakers with handle width ≤ 8mm	

**BD-D14**  
**MULTI-FUNCTION MINIATURE BREAKER LOCKOUT**

Unit: mm



**Product Features**

- Made from engineering plastic strengthened nylon PA and chrome plated brass screw.
- With locking screws, can be locked without tools.
- Widely used: applicable to all kinds of small and medium sized MCCB, and any miniature circuit breaker.
- Can be customized stainless steel brand.

**Product Selection**

Model	Description	Application
BD-D14	Suitable for all kinds of small and medium sized moulded case circuit breakers and any mini circuit breakers	

**BD-D15/D15W**  
**MULTI-FUNCTION CIRCUIT BREAKER LOCKOUT**

Unit: mm



**Product Features**

- Made of strong reinforced nylon and chrome plated brass screws;
  - With locking screw, no tools can be easily locked;
  - Can use the lock beam Dia. ≤ 7mm safety padlock lock;
  - Original U-shaped stainless steel insert, can ensure there will be no situation after locking swing
- With locking screw, no tools can be easily locked;

**Product Selection**

Model	Description	Application
BD-D15	Suitable for medium circuit breaker (handle width ≤ 20mm) The bottom of the lock body with pedal	
BD-D15W	Suitable for medium circuit breaker (handle width ≤ 20mm) without pedal at bottom of the lock body	

ELECTRICAL LOCKOUT

ELECTRICAL LOCKOUT

**BD-D16/D16L**  
**LARGE TYPE CLRCUIT**  
**BREAKER LOCKOUT**

Unit: mm

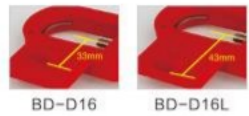
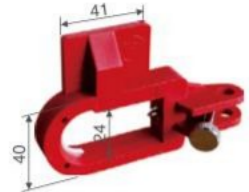

**Product Features**

- Made of rugged reinforced nylon and chrome plated brass screws;
- With locking screw, do not need tools to lock, unique U-shaped stainless steel sheet design makes the locking more solid and reliable;
- It can be locked using a padlock with a shackle Dia. of 7mm or less.

**Product Selection**

Model	Description	Application
BD-D16	Suitable for all kinds of large moulded case circuit breaker (handle thickness ≤ 20mm), and special push-button circuit breaker	
BD-D16L	Suitable for very few old closed stroke is longer plastic case circuit breaker	

**BD-D17/D18**  
**BIDIRECTIONAL MEDIUM**  
**CIRCUIT BREAKER LOCKOUT**

Unit: mm

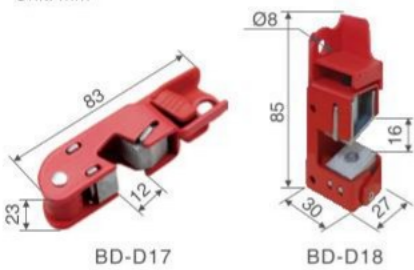

**Product Features**

- The lock body is made of die-cast aluminum alloy, nylon and steel, and the surface is sprayed treatment.
- With locking screw, no tools can be easily locked.

**Product Selection**

Model	Description	Application
BD-D17	7.5mm ≤ handle wide ≤ 12mm Small and medium circuit breaker	
BD-D18	8mm ≤ handle wide ≤ 16mm Small and medium circuit breaker	

**BD-D17-1/D18-1**  
**BIDIRECTIONAL MEDIUM**  
**CIRCUIT BREAKER LOCKOUT**

Unit: mm

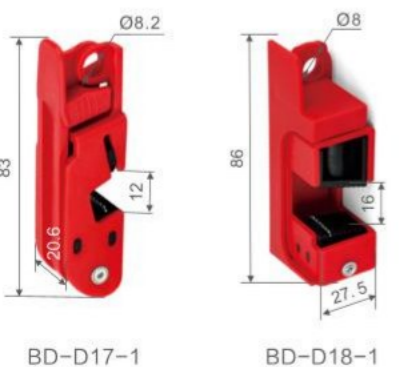

**Product Features**

- The lock body is made of PA66+20GF%
- Comes with locking screws, no tools required can be locked by yourself.

**Product Selection**

Model	Description	Application
BD-D17-1	Suitable for small and medium-sized circuit breakers with handle width ≤ 12mm	
BD-D18-1	Suitable for small and medium-sized circuit breakers with 8mm ≤ handle width ≤ 16mm	

**BD-D-D7**  
**Circuit Breaker Lockout**

Unit: mm

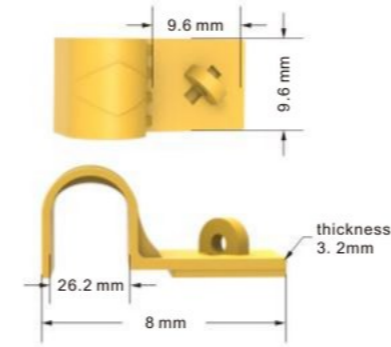

**Product Features**

- Made of alloy engineering plastic;
- Compatible with safety padlocks having shackle diameter ≤ 6.2mm;
- Fixed by screw or 3M adhesive.

**Product Selection**

Model	Description	Application
BD-D-D7	Applicable to the on and off positions of the switch.	

**BD-D-D8**  
**Circuit Breaker Lockout**

Unit: mm

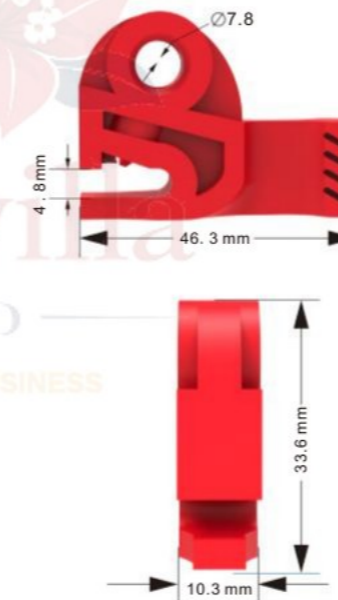

**Product Features**

- Made of alloy engineering plastic;
- Compatible with safety padlocks having shackle diameter ≤ 7mm;
- Locking is done with a screwdriver.

**Product Features**

Model	Description	Application
BD-D-D8	Suitable for circuit breaker locks	



### BD-D-D9 Circuit Breaker Lockout

Unit: mm

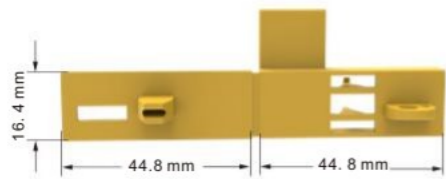

#### Product Features

- Lock body is made of engineering plastic reinforced nylon PA.
- Compatible with safety padlocks having shackle diameter  $\leq 4$ mm

#### Product Selection

Model	Description	Application
BD-D-D9	Suitable for circuit breaker locks	

### BD-DPC4 Circuit Breaker Lockout

Unit: mm

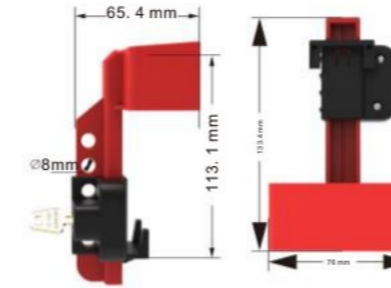

#### Product Features

- Lock body: injection-molded PA+ABS; lock cylinder made of brass.
- Integrates lock and key management functions, reserved with two shared locking holes. Innovates in aspects such as portability and reducing the need for lock storage during lockout/tagout procedures.

#### Product Selection

Model	Description	Application
BD-DPC4	Suitable for locking Anderson plugs with or without handle, 175A and 350A..	

### BD-D-D10 Circuit Breaker Lockout

Unit: mm



#### Product Features

- Made of PP alloy engineering plastic
- Compatible with safety padlocks having shackle diameter  $\leq 7$ mm
- Fixed by screw or 3M adhesive.
- Can lock keyholes and other holes with a diameter of 30mm.

#### Product Selection

Model	Description	Application
BD-D-D10-1	Lock body in red, suitable for locking holes such as recessed switches and keyholes.	
BD-D-D10-2	Lock body in yellow, suitable for locking holes such as recessed switches and keyholes.	

- Knife switch safety anti-accident device

### BD-D44 Knife switch safety anti-accident device

Unit: mm

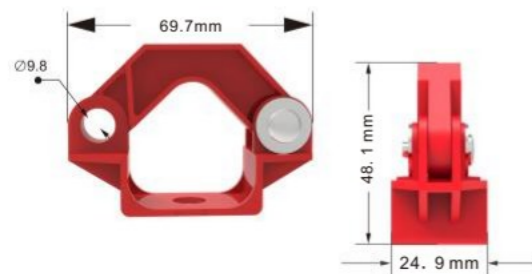

#### Product Features

- Made of alloy engineering plastic.
- Compatible with safety padlocks having shackle diameter  $\leq 8$ mm

#### Product Selection

Model	Description	Application
BD-D44-1	Locking suitable for the grip.	
BD-D44-4	Locking suitable for the grip.	

### BD-DR1-P001/DR1-P011 Fuse Lockout

Unit: mm



BD-DR1-P001



BD-DR1-P011

#### Product Features

- The housing is made of hard ABS+PC material.
- The locking/unlocking mechanism features a clever two-stage structure with noticeable tactile feedback.
- The rotating part for unlocking is designed with an ergonomic structure to facilitate force application when rotating to unlock or lock.

#### Product Selection

Model	Description	Application
BD-DR1-B01	Locks screw-type fuse, preventing accidental touch, effectively avoiding safety accidents caused by incorrect switching, live operation, or entering live intervals.	
BD-DR1-B11	Locks screw-type fuse, preventing safety accidents caused by incorrect switching, live operation, or entering live intervals.	

ELECTRICAL LOCKOUT

ELECTRICAL LOCKOUT

**BD-D19**  
**DOUBLE-END LOCKOUT**

Unit: mm

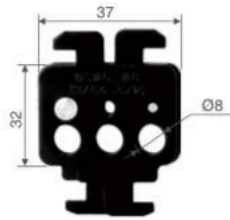

BD-19

**Product Features**

- Made from Steel.
- Suitable for Schneider NSX accessory locking equipment Molded case circuit breakers.
- Several person management and usage.

**Product Selection**

Model	Description	Application
BD-19	Suitable for Schneider special circuit breaker	

**BD-D20**  
**SMALL-SCALE MINIATURE**  
**CIRCUIT BREAKER LOCKOUT**

Unit: mm



BD-20

**Product Features**

- The lock body is made of nylon;
- With locking screw, no tools can be easily locked.

**Product Selection**

Model	Description	Application
BD-20	7mm ≤ handle width ≤ 15mm Small circuit breaker	

**BD-D21**  
**SNAP-ON BREAKER LOCKOUT**

Unit: mm

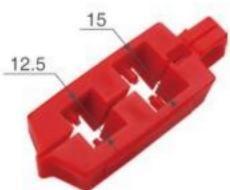

BD-D21

**Product Features**

- Made of modified engineering plastic nylon PA;
- Simple and convenient to use, just stick in the correct position and lock it;
- Double control design, can be used for different sizes of switch button;
- It can be locked using two security padlocks with the Dia. of the lock beam ≤ 7mm;

**Product Selection**

Model	Description	Application
BD-D21	Suitable for very few small circuit breakers with holes on both sides of the handle	

**BD-D22/D22-2**  
**BREAKER LOCKOUT**

Unit: mm

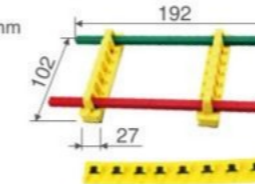

BD-D22

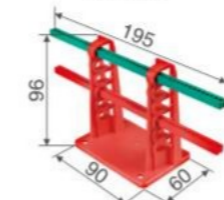

BD-D22-2

**Product Features**

- Made of engineering plastic alloy.
- The self-adhesive track on the back can be permanently fixed to the distributor (just clean the surface of the distributor and paste, no drilling).
- Can be locked by padlock with shackle diameter ≤ 7mm.
- Red stop rod indicates that the switch is off. Green stop rod indicates that the switch is on.

**Product Selection**

Model	Description	Application
BD-D22	Lock switches of large and irregular shape (Main rod length 190mm)	
BD-D22-2	Universal knife brake--main rod length is 195mm	

**BD-D23**  
**UNIVERSAL WALL-TYPE**  
**SWITCH COVER**

Unit: mm



BD-D23

**Product Features**

- Made of engineering plastic ABS and acrylic.
- English warning sign on the body is available.
- Can be locked with safety padlock of shackle Dia. ≤ 7mm.

**Product Selection**

Model	Description	Application
BD-D23	Suitable for wall switch, base hole size: 38x40mm	

**BD-D24/D24W**  
**SELF-LOCKING MEDIUM**  
**CIRCUIT BREAKER LOCKOUT**

Unit: mm



BD-D24



BD-D24W

**Product Features**

- Made from rugged reinforced nylon and chrome plated brass screw.
- Comes with locking screw, can lock conveniently by itself without tools.
- Widely used, suitable for handle width ≤ 12mm, Keyhole Dia. 8.6mm

**Product Selection**

Model	Description	Application
BD-D24	With pedal	
BD-D24W	Without pedal	

ELECTRICAL LOCKOUT

ELECTRICAL LOCKOUT

**BD-D25**  
**POWER HANDLE LOCKOUT**

Unit: mm



**Product Features**

- The body is made from ABS.
- Suitable for switch of handle type.
- Can be fixed on electrical board with strong self-adhesive tape. At the same time, it has installing hole and can also be fixed by screw.

**Product Selection**

Model	Description	Application
BD-D25	8mm ≤ Handle width ≤ 16mm	

**BD-D26**  
**SIMPLE CIRCUIT BREAKER LOCKOUT**

Unit: mm



**Product Features**

- Made of aluminum alloy
- It should be used with a small flat-head screwdriver.

**Product Selection**

Model	Description	Application
BD-D26	Suitable for mini circuit breaker	

**BD-D27**  
**PIN OUT MINIATURE CIRCUIT BREAKER LOCKOUT**

Unit: mm



**Product Features**

- The lock body is made of stable and wear resistant PBT material;
- Maximum Dia. of locking beam: 8mm;
- Yellow, other colors can be customized;

**Product Selection**

Model	Description	Application
BD-D27	Suitable for mini circuit breaker	

**BD-D28**  
**PIN OUT SCHNEIDER MINIATURE CIRCUIT BREAKER LOCKOUT**

Unit: mm

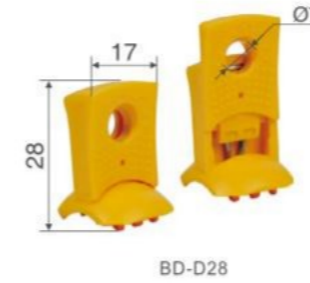

**Product Features**

- The lock body is made of stable and durable PA66+ABS material;
- Maximum Dia. of locking beam: 6mm;
- Yellow, other colors can be customized.

**Product Selection**

Model	Description	Application
BD-D28	Suitable for Schneider special circuit breaker	

**BD-D29**  
**MEDIUM CIRCUIT BREAKER LOCKOUT**

Unit: mm



**Product Features**

- Made of strong and durable engineering plastic PC material;
- With locking screw, no tools can be easily locked;
- Maximum handle size: width 75mm x thickness 23mm;
- Allow 3 padlocks with lock shackle ≤ 8mm;

**Product Selection**

Model	Description	Application
BD-D29	Mould-case circuit breaker, Minimum size of opening position ≥ 19mm	

**BD-D31**  
**ELECTRICAL/PNEUMATIC PLUG LOCKOUT**

Unit: mm



**Product Features**

- Made from ABS material;
- Double open and quadrilateral lockout design, suitable for all kinds of electrical and pneumatic; plug (max Dia. 89mm, max length 127mm) and air hose external screw thread adaptor;
- The hole in the lockout can lock cable and the bent down pneumatic external screw thread accessory.
- Accommodates 4 pieces padlocks with shackle Dia. less than 7mm to lock it.

**Product Selection**

Model	Description	Application
BD-D31	5 kinds of pneumatic lock apertures can be locked: 9.5mm, 10.4mm, 11.4mm, 12mm, 18.2mm	

ELECTRICAL LOCKOUT

ELECTRICAL LOCKOUT

**BD-D32**  
**PIN OUTWARD MINIATURE**  
**CIRCUIT BREAKER LOCKOUT**

Unit: mm



**Product Features**

- The body is made from PA66+20GF%.
- Lock the circuit breaker in the closed state to prevent false opening.
- Universal Europe, Asia miniature circuit breaker equipment.
- Yellow, other colors to order.

**Product Selection**

Model	Description	Application
BD-D32	It can be used with a padlock with a lock beam diameter of ≤5mm	

**BD-D33/D34**  
**INDUSTRIAL PLUG LOCKOUT**

Unit: mm

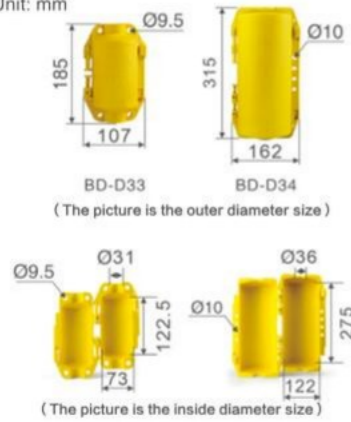

**Product Features**

- Made from PP.
- Suitable for locking kinds of industrial plugs.
- Allow 4 padlocks to lock at the same time.
- Different colors can be customized.
- Part code Description Application.

**Product Selection**

Model	Description	Application
BD-D33	Applicable plug range: length ≤ 120mm Dia. ≤ 69mm	
BD-D34	Applicable plug range: length ≤ 261mm Dia. ≤ 114mm	

**BD-D35/D36**  
**SMALL CIRCUIT**  
**BREAKER LOCKOUT**

Unit: mm

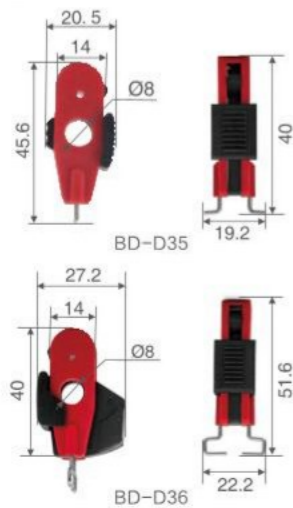

**Product Features**

- Made from durable reinforced nylon.
- Keyhole diameter 8mm.

**Product Selection**

Model	Description	Application
BD-D35	Suitable for small circuit breakers	
BD-D36	Suitable for small circuit breakers 1 pole	

**BD-D37/D38**  
**MOLDED CASE CIRCUIT**  
**BREAKER LOCKOUT**

Unit: mm



**Product Features**

- The lock body is made of reinforced nylon.
- Using thumb screws to fix the lockout on the switch handle, and then fasten the cover to the thumb screws to prevent loosening.
- The base clamps onto the bottom of the lock body very easily.

**Product Selection**

Model	Description	Application
BD-D37	Suitable for single-hole locking management of small and medium-sized molded case circuit breakers with handle width ≤ 19mm.	
BD-D38	Suitable for single-hole locking management of medium and large plastic case circuit breakers with handle width ≤ 70mm.	

Using thumb screws to fix the lockout on the switch handle, and then fasten the cover to the thumb screws.

**Product Features**

- The lock body is made of 304 stainless steel.
- Can be locked using 2 safety padlocks with shackle diameter ≤ 8mm.

**Product Selection**

Model	Description	Application
BD-D39	Applicable to Schneider EZD type, EZC100 type, CHNT CDM3-125 type	

**BD-D39**  
**SMALL CIRCUIT**  
**BREAKER LOCKOUT**

Unit: mm

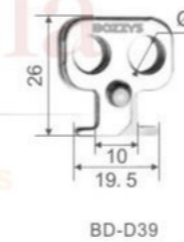

**BD-D41/D42/D43**  
**ELECTRICAL PLUG LOCKOUT**

Unit: mm

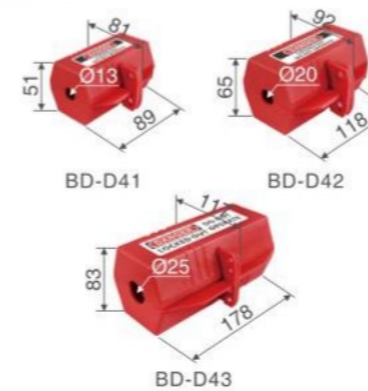

**Product Features**

- Made from rugged polypropylene.
- Double open and hexagon lockout design, suitable for all kinds of industrial plugs.
- Accommodates 2 to 4 pieces padlocks with shackle Dia. less than 7mm to lock it at the same time.

**Product Selection**

Model	Description	Application
BD-D41	For cables with a Dia. of 13mm	
BD-D42	For cables with a Dia. of 20mm	
BD-D43	For cables with a Dia. of 25mm	

ELECTRICAL LOCKOUT

ELECTRICAL LOCKOUT

**BD-D41A/D42A**  
**ELECTRICAL PLUG LOCKOUT**

Unit: mm



**Product Features**

- Made of engineering plastic PA+ABS;
- Insulation corrosion resistant,durable, strong,not easy to deformation,impact resistance;
- Double open cylinder lock design,can be used for all kinds of industrial plug safety lock;
- It can be locked with 2 safety padlocks with the Dia.of the lock shackles≤7mm.

**Product Selection**

Model	Description	Application
BD-D41A	Inner Dia.58mm x inner length 95mm x hole Dia.20mm	
BD-D42A	Inner Dia.78mm x inner length 170mm x hole Dia.25mm	

**BD-D45**  
**INDUSTRIAL WATERPROOF SOCKET LOCKOUT**

Unit: mm



**Product Features**

- Made from PP material;
- With hasp to lock industrial waterproof socket.
- Can accommodate several padlocks to lock it at the same time with hasp.

**Product Selection**

Model	Description	Application
BD-D45-1	Suitable for small industrial plugs,Lock body hole size: inner diameter 40mm,outer diameter 44mm;	
BD-D45-2	Suitable for small industrial plugs,Lock body hole size: inner diameter 52mm,outer diameter 56mm;	
BD-D45-3	Suitable for small industrial plugs,Lock body hole size: inner diameter 55mm,outer diameter 59mm;	
BD-D45-4	Suitable for medium-sized industrial plugs,Lock body hole size: inner diameter 63mm,outer diameter 67mm;	
BD-D45-5	Suitable for large industrial plugs,Lock body hole size: inner diameter 73mm,outer diameter 77mm;	

**BD-D46**  
**INDUSTRIAL WATERPROOF PLUG LOCKOUT**

Unit: mm



**Product Features**

- Made from engineering plastic PC material.
- Suitable for locking kinds of industrial waterproof plugs.

**Product Selection**

Model	Description	Application
BD-D46	Suitable for 16-125A industrial waterproof plug	

**BD-D50**  
**EMERGENCY BUTTON LOCKOUT'S BASE**



**Product Features**

- Used with emergency stop lockout,such as BD-D53,BD-D55,BD-D56.
- Install on the controller button forever,avoid accidentally touch,easy to use.

**Product Selection**

Model	Description	Application
BD-D50-1	suitable for button base's Dia.: 16mm to 22mm	
BD-D50-2	suitable for button base's Dia.: 27mm to 32mm	

**BD-D51/D52**  
**EMERGENCY STOP LOCKOUT**

Unit: mm



**Product Features**

- Made from high strength transparent glass resin PC.
- Install on the controller button forever,avoid accidentally touch.
- Color:transparent,and red.

**Product Selection**

Model	Description	Application
BD-D51	install hole inner Dia.:22mm	
BD-D52	install hole inner Dia.:30mm	

**BD-D51A/D52A**  
**EMERGENCY STOP LOCKOUT**

Unit: mm



**Product Features**

- Made from high strength transparent glass resin PC.
- Install on the controller button forever,avoid accidentally touch.
- Color:transparent,and red.

**Product Selection**

Model	Description	Application
BD-D51A	install hole inner Dia.:22mm	
BD-D52A	install hole inner Dia.:30mm	

ELECTRICAL LOCKOUT

ELECTRICAL LOCKOUT

**BD-D53/D55/D56**  
**EMERGENCY STOP LOCKOUT**

Unit: mm

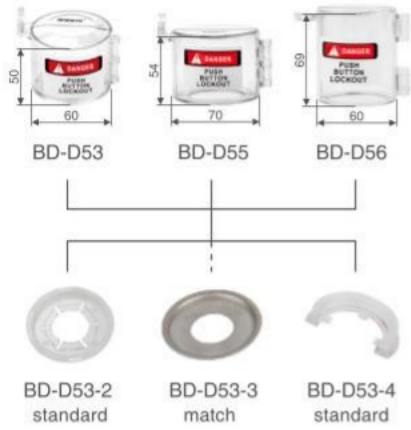

**Product Features**

- Made from high-strengthened transparent glass resin PC.
- Avoid dismantling, easy to install, install the base on the bottom of the emergency stop switch, can lock and remove at random.
- Install on the push or spiral release emergency stop button, avoid accidentally touch.
- When no need to lock at ordinary time, leave the base at site, will not affect the operation at all. Put the cover to lock the base when necessary

**Product Selection**

Model	Description	Application
BD-D53	Inner Dia.55mm x inner height 43mm, hole Dia. 46mm	
BD-D55	Inner Dia.65mm x inner height 49mm, hole Dia. 46mm	
BD-D56	Inner Dia.54.5mm x inner height 64mm, hole Dia. 45.5mm	
BD-D53-2	Suitable for inner Dia. 22/30mm hole button base	
BD-D53-3	Suitable for inner Dia. 22mm hole button base steel base	
BD-D53-4	Suitable for inner Dia. 30/38mm hole button base	

**BD-D54**  
**EMERGENCY STOP LOCKOUT**

Unit: mm



**Product Features**

- Made from high-strengthened transparent glass resin PC.
- Install on the wall switch or change-over switch and other electrical appliances permanently, open it then operate, avoid accidentally touch.

**Product Selection**

Model	Description	Application
BD-D54	Dia. of installing hole: 20mm or 30mm	

**BD-D57/D58**  
**EMERGENCY STOP LOCKOUT**

Unit: mm



**Product Features**

- Made from high-strengthened transparent glass resin PC.
- Avoid dismantling, easy to install, install the base on the bottom of the emergency stop switch, can lock and remove at random.
- Install on the push or spiral release emergency stop button, avoid accidentally touch.
- When no need to lock at ordinary time, leave the base at site, will not affect the operation at all. Put the cover to lock the base when necessary

**Product Selection**

Model	Description	Application
BD-D57	hole's diameter:57mm; wall thickness: 3mm	
BD-D57-1	Suitable for hole button bases with an inner diameter of 34~50mm	
BD-D58	hole's diameter:80mm; wall thickness: 2mm	
BD-D58-2	Suitable for hole button bases with an inner diameter of 24~67mm	

**BD-D59**  
**SHIP-LINK BUTTON SWITCH LOCKOUT**

Unit: mm



**Product Features**

- The main body is made of engineering PC plastic, which is waterproof, impact-resistant, insulated and anti-leakage.
- The transparent cover realizes visual management. Easy to lock, easy to use, and prevent Prevent misoperation.
- The 3M glue installation method is convenient and efficient.

**Product Selection**

Model	Description	Application
BD-D59	Suitable for Ship-link button switch lockout size: width*length: 26mm*32mm	

**BD-D60**  
**EMERGENCY STOP LOCKOUT**

Unit: mm



**Product Features**

- Transparent high-strengthened glass resin PC material.
- No need disassemble, easy to install, just install the base on the bottom of the emergency stop switch, it can be locked and removed at will.
- Permanently installed on the emergency stop button which can push-pull or screw release to prevent accidental touch.
- According to the reserved holes of the lock, it can be locked with 2-4 safety padlocks with the Dia. of the lock beam ≤ 7mm can be locked

**Product Selection**

Model	Dimensions inside the base	Inner height of the base
BD-D60-1	Dia.27.5mm	42mm
BD-D60-2	Dia.75mm	65.5mm
BD-D60-3	45.5x45.5mm	60mm
BD-D60-4	70x70mm	60mm
BD-D60-5	84x84mm	100.5mm

**BD-D63/D64**  
**WALL SOCKET LOCKOUT**

Unit: mm



**Product Features**

- Made from high-strengthened transparent glass resin PC.
- Permanently installed on electrical appliances such as wall or transfer switches. Need to open the lock to operate to prevent accidental touch.
- Can fix it by self-tapping screw or 3M double sided glue.

**Product Selection**

Model	Description	Application
BD-D63	Mounting hole size: 74x74mm	
BD-D64	Mounting hole size: 134x74mm	

**BD-D65**  
**CONTROL PANEL LOCKOUT**

Unit: mm

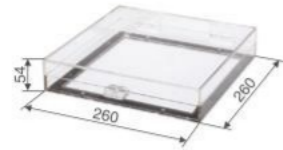

BD-D65

**Product Features**

- Made from acrylic panel.
- With support rack design, can operate the panel conveniently.
- Can fix it by automatic screw of 3M double-sided tape.
- It is customized product, the base can be coated steel or transparent mask.
- The size of this product can be customized.

**Product Selection**

Model	Description	Application
BD-D65	Mounting hole size: 220x220mm, inner height 45mm, Can lock kinds of appliance's touch pnels	

**BD-D66**  
**SWITCH LOCKOUT**

Unit: mm

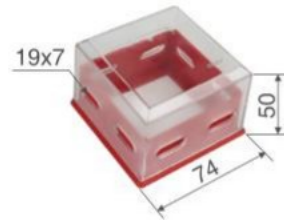

BD-D66

**Product Features**

- The main cover is made of sturdy and durable engineering PC plastic, and the base is made of PA material, which has good product stability.
- The transparent cover realizes visual management, and the switch status of electrical appliances can be observed directly without unlocking operation, which is convenient to use.
- The four-sided hollow keyhole design can realize the safe management of locking by multiple people, and the locking is convenient and safe.
- The reserved hole design of the base is easy to install, and it can also be installed with 3M adhesive. Various installation and use methods are efficient and convenient.

**Product Selection**

Model	Description	Application
BD-D66	Bottom of inner box: 51mm x 51mm Internal height: 48.5mm	

**BD-D67**  
**SWITCH LOCKOUT**

Unit: mm



BD-D67

**Product Features**

- The main body is made of engineering PC plastic, which is waterproof, impact-resistant, insulated and anti-leakage.
- The transparent cover realizes visual management. Easy to lock, easy to use, and prevent misoperation.
- The 3M adhesive installation method is convenient and efficient.

**Product Selection**

Model	Description	Application
BD-D67	Bottom of inner box: 70mm x 70mm	

**BD-D67A**  
**EMERGENCY STOP LOCKOUT**

Unit: mm

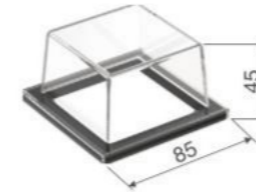

BD-D67A

**Product Features**

- Made of engineering plastic PC, it is waterproof, impact-resistant, insulated and leak-proof;
- Visual management of the protective cover, easy to lock, easy to use, prevent misoperation;
- Rubber magnetic installation method, magnetic locking, can be locked or removed at any time;

**Product Selection**

Model	Description
BD-D67A	Inner dimensions: bottom 58x58mm, height 42.7mm

**BD-D69-1/D69-2**  
**ROTATING ELECTRICAL LOCKOUT**

Unit: mm



BD-D69-1

BD-D69-2

**Product Features**

- Made from high strength transparent glass resin PC;
- Reserved holes for locking equipment, equipment button keys, etc.;
- Color: Transparent.

**Product Selection**

Model	Description	Application
BD-D69-1	Suitable for button keys with button height ≤ 8.5mm and button diameter ≤ 35mm, or electrical holes with diameter ≤ 30mm	
BD-D69-2	Suitable for button keys with button height ≤ 21mm and button diameter ≤ 43mm; or button keys with 21mm ≤ button height ≤ 27mm and button diameter ≤ 35mm	

**BD-D71**  
**LOCKOUT BAG**

Unit: mm



BD-D71

BD-D71-2

BD-D71-3

**Product Features**

- Made of wear-resistant polyester cloth;
- Insert the PVC liner to prevent others from touching the buttons on the lift controller;
- There is enough space to realize to lockout a variety of driving control button and various oversized plugs or parts;
- English warning signs are printed on the surface.

**Product Selection**

Model	Description	Application
BD-D71	Elasticated pocket for locking	
BD-D71-2		
BD-D71-3		

ELECTRICAL LOCKOUT

ELECTRICAL LOCKOUT

**BD-D75**  
**INDUSTRIAL ELECTRICAL LOCKOUT**

Unit: mm



**Product Features**

- Nylon Fabric,ABS,Cold Rolled Steel,Polyester Fiber.
- It can be locked with 4 safety padlocks with the Dia.of the lock shackle ≤12mm
- Lockout long hanging controller to prevent others from activating the device, fabricpanels can be folded and stretched for easy storage and transport.

**Product Selection**

Model	Description	Application
BD-D75	For 100-450mm long hanging controller	

**BD-D81**  
**ELECTRICAL HOLE LOCKOUT**

Unit: mm

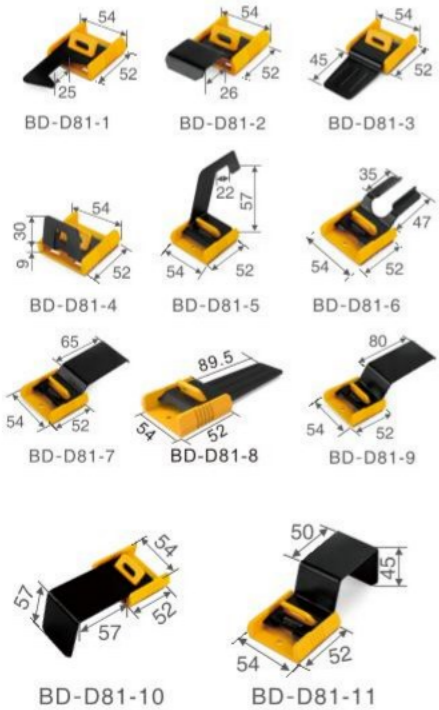

**Product Features**

- The lock body is made of alloy engineering plastics and A3 steel plate(painted);
- It can realize the locking of various non-standard electrical appliances or power distribution cabinets;
- Fixed by double-sided 3M glue or screws;
- It can install locks of different shapes according to customer requirements;
- Base size: width 54mm x length 52mm, metal plate thickness 2mm.

**Product Selection**

Model	Description	Application
BD-D81-1	Lock knob switch,change over switch.	
BD-D81-2	Lock button switch,the lock hole of the distribution cabinet	
BD-D81-3	Lock cabinet door,electrical handle hole,low voltage cabint and so on.	
BD-D81-4	Lock switch handle, change over switch of the drawer cabinet.	
BD-D81-5	Lock knife switch,handle switch and so on.	
BD-D81-6	Lock knob switch,change over switch.	
BD-D81-7	Lock button switch,the lock hole of the distribution cabinet.	
BD-D81-8	The control room requires all lockable cabinet doors to be equipped with anti-tamper seals.	
BD-D81-9	Lock doors,electrical handle hole.	
BD-D81-10	Lock button switch,the lock hole of the distribution cabinet.	
BD-D81-11	Lock knife switch,handle switch and so on.	

**BD-D82**  
**ELECTRICAL HOLE LOCKOUT**

Unit: mm



**Product Features**

- Made from engineering plastic PC,rubber,screw and extrusion sheet.
- Rotate the knob on the lockout,then the rubber is out of shape,it is locked.
- Can custom made kinds of rubber hole stopple to lock non-standard electrical hole. computer's power socket.
- Custom made different specification rubbers stopple according to electrical appliance hole to lock.

**Product Selection**

Model	Description	Application
BD-D82-1	To lock kinds of non-standard shape,handles holes and so on	
BD-D82-2		
BD-D82-3	To lock kinds of non-standard shape,handles holes and so on,3 holes	

**BD-D83**  
**PLUG LOCKOUT**

Unit: mm



**Product Features**

- The lock body is made of engineering alloy plastic ABS+PC;
- Use the built-in lock cylinder to lock directly;
- Suitable for locking American standard plugs ;

**Product Selection**

Model	Description	Application
BD-D83	Use the built-in lock cylinder to lock directly. Suitable for locking American standard plugs	

**BD-D100/D110**  
**CIRCUIT BREAKER LOCKOUT**

Unit: mm



**Product Features**

- The main body is made of engineering PC plastic;
- Keyhole Dia.8.6mm;
- Suitable for medium and miniature breaker.

**Product Selection**

Model	Description	Application
BD-D100	A:46mm abc:78mmx29.5mmx35mm	
BD-D110	A:50mm abc:90mmx29.5mmx47mm	

**DPD1/DPD2  
 SELF-LOCKING CLAMP-ON  
 BREAKER LOCK**

Unit: mm

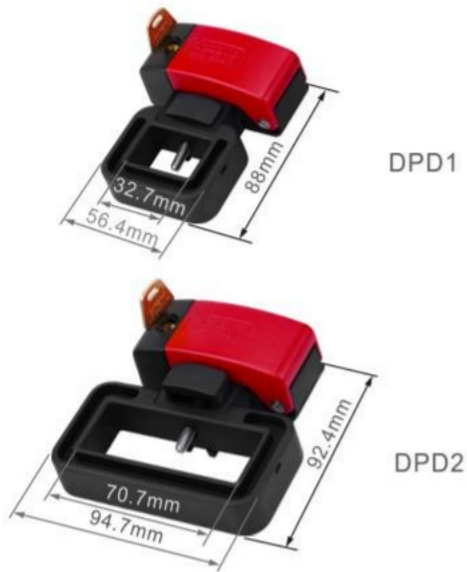

**Product Features**

- Lock the circuit breaker in the closed state to prevent accidental opening.
- Made of PA;
- Suitable for medium/large plastic case circuit breakers;

**Product Selection**

Model	Description	Application
DPD1	Maximum locking range: handle width 32mm, thickness 18mm	
DPD2	Maximum locking range: handle width 70mm, thickness 22mm	

**DPX1  
 SELF-LOCKING MINIATURE  
 CIRCUIT BREAKER LOCKOUT**

Unit: mm



BD-DPX1

**Product Features**

- Lock the circuit breaker in the closed state to prevent accidental opening.
- Made of PA66+20%GF.
- Suitable for small circuit breakers (handle thickness <10mm)

**Product Selection**

Model	Description	Application
DPX1	Suitable for small circuit breakers (handle thickness <10mm)	

**DPC1/DPC2/DPC3  
 PLUG LOCKOU**

Unit: mm

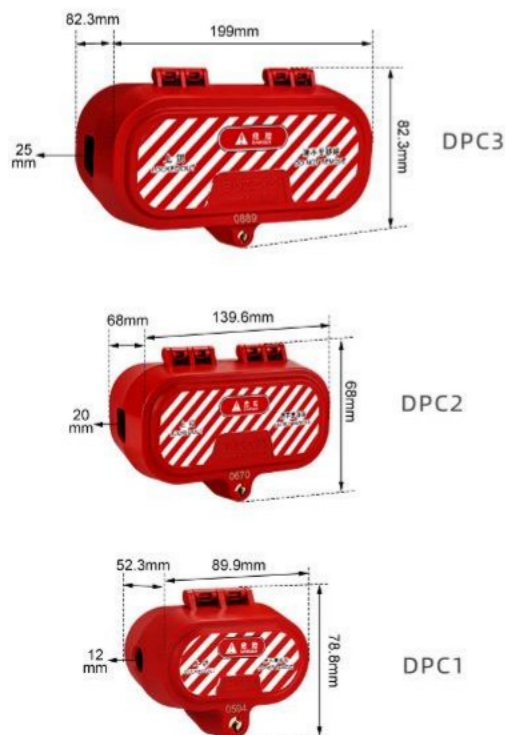

**Product Features**

- The new lockout has a built-in Lock cylinder design and can be locked directly;
- Made of engineering plastic PA+ABS
- Can be use for all kinds of industria plug or interfaces safety lock

**Product Selection**

Model	Description	Application
DPC1	Can be use for all kinds of industria plug or interfaces safety lock	
DPC2		
DPC3		

**DPR1/RDPR2  
 FUSE LOCKOUT**

Unit: mm



DPR1

RDPR2

**Product Features**

- Lock the circuit breaker in the closed state to prevent accidental opening.
- Made of PA+ABS.
- Suitable for small circuit breakers (handle thickness <10mm)

**Product Selection**

Model	Description	Application
DPR1	suitable for fuse bases with diameter of 10mm	
RDPR2	suitable for fuse bases with diameter of 14mm	

**DPJ1  
 FIXED SWITCH LOCKOUT**

Unit: mm



BD-DPJ1

**Product Features**

- Permanently installed on the control button to prevent accidental touching;
- Made of PC;
- Button size<45mm, Installation size<22m

**Product Selection**

Model	Description	Application
DPJ1	Button size<45mm, Installation size<22m	

ELECTRICAL LOCKOUT

ELECTRICAL LOCKOUT

**BD-D200**  
**MULTI-FUNCTION**  
**ADJUSTABLE MEDIUM**  
**BREAKER LOCKOUT**

Unit: mm



**Product Features**

- Made from strong and durable strengthened nylon.
- Keyhole Dia. 7.6mm.
- Suitable for medium and miniature breaker..

**Product Selection**

Model	Description	Application
BD-D200	handle widths≤8mm Small and medium circuit breaker	

**BD-D301P~D304P**  
**PROTECTIVE COVER FOR**  
**CIRCUIT BREAKER**

Unit: mm



**Product Features**

- Made of reinforced nylon and transparent high-strengthened glass resin PC.
- Easy to install. just place the protective cover on the circuit breaker, which can be locked and removed at will.
- Can lock 2 safety padlocks with shackle Dia.≤7mm together..

**Product Selection**

Model	Description	Application
BD-D301P	Suitable for various miniature circuit breakers	
BD-D302P		
BD-D303P		
BD-D304P		

**BD-D701~D704**  
**FLAT PUSH BUTTON**  
**PROTECTIVE COVER**

Unit: mm



**Product Features**

- Made of engineering plastic ABS and transparent high-strength glass resin PC.
- The transparent cover realizes visual management and protect the buttons from accidental touch during work and production.
- Widely used and easy to install.

**Product Selection**

Model	Dimensions inside	Dia. of installing hole
BD-D701	Length 20mm x width 18mm x height 12mm	16mm
BD-D702	Length 24mm x width 18mm x height 12mm	16mm
BD-D703	Length 30mm x width 30mm x height 13mm	22mm
BD-D704	Length 34mm x width 36mm x height 20mm	22mm

**BD-D711/D712**  
**TRANSPARENT FLAT BUTTON**  
**PROTECTIVE COVER**

Unit: mm

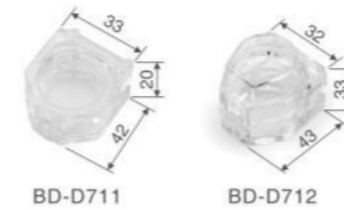

**Product Features**

- Made of high-strengthened glass resin PC.
- The transparent cover realizes visual management and protect the buttons from accidental touch during work and production.
- Widely used and easy to install.

**Product Selection**

Model	Description	Dimensions inside	Dia. of installing hole
BD-D711	Suitable for flat buttons	Length 30mm x width 30mm x height 16mm	22mm
BD-D712	Suitable for knobs	Length 30mm x width 32mm x height 25mm	

**BD-D721~D723**  
**TRANSPARENT PUSH BUTTON**  
**PROTECTIVE COVER**

Unit: mm



**Product Features**

- Made of high-strengthened glass resin PC.
- The transparent cover realizes visual management and protect the buttons from accidental touch during work and production.
- Widely used and easy to install.
- Only can lock 1 safety padlock with shackle Dia.≤7mm.

**Product Selection**

Model	Dimensions inside	Dia. of installing hole
BD-D721	Dia.40mm x height 28mm	16mm
BD-D722	Dia.45mm x height 27mm	22mm
BD-D723	Dia.45mm x height 27mm	25mm

**BD-D731~D734**  
**YELLOW BASE PUSH BUTTON**  
**SWITCH PROTECTIVE COVER**

Unit: mm



**Product Features**

- Made of engineering plastic ABS and transparent high-strength glass resin PC.
- The transparent cover realizes visual management and protect the buttons from accidental touch during work and production.
- Widely used and easy to install.
- Only can lock 1 safety padlock with shackle Dia.≤7mm.

**Product Selection**

Model	Dimensions inside	Dia. of installing hole
BD-D731	Dia.49mm x height 32mm	22mm
BD-D732	Dia.49mm x height 37mm	
BD-D733	Dia.49mm x height 51mm	25mm
BD-D734	Dia.49mm x height 37mm	

ELECTRICAL LOCKOUT

ELECTRICAL LOCKOUT

**BD-D749/D750**  
**EMERGENCY STOP PUSH**  
**BUTTON PROTETIVE COVER**

Unit: mm

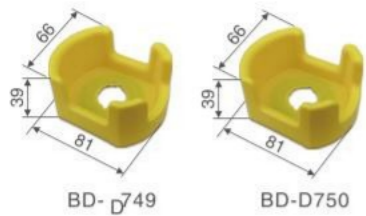

**Product Features**

- Made of strong and durable reinforced nylon.
- Easy and quick to install to warn operations effectively.
- The installation method with back glue which is convenient and efficient.

**Product Selection**

Model	Dimensions inside	Dia. of installing hole
BD-D749	Length 50mm x width 67mm x height 35mm.	22mm
BD-D750	Length 50mm x width 67mm x height 35mm.	25mm

**BD-D741~D748**  
**YELLOW PUSH BUTTON**  
**WITCH PROTECTIVE COVER**



**Product Features**

- Made of strong and durable reinforced nylon.
- Easy and quick to install to warn operations effectively.
- Prevent misoperation, safety production first.

**Product Selection**

Model	External dimensions	Dimensions inside	Dia. of installing hole
BD-D741	Dia.31mm x height 20mm	Dia.24mm x height 18mm	16mm
BD-D742	Dia.44mm x height 20mm	Dia.24mm x height 18mm	
BD-D742P	Dia.52mm x height 23mm	Dia.31mm x height 21mm	
BD-D743	Dia.47mm x height 27mm	Dia.41mm x height 42mm	
BD-D744	Dia.68mm x height 30mm	Dia.62mm x height 28mm	
BD-D745	Length 69mm x width 59mm x height 32mm	Length 60mm x width 57mm x height 27mm	22mm
BD-D746	Length 71mm x width 65mm x height 48mm	Length 65mm x width 66mm x height 43mm	
BD-D747	Dia.60mm x height 29mm	Dia.54mm x height 26mm	
BD-D747S	Dia.48mm x height 29mm	Dia.42mm x height 26mm	
BD-D748	Length 48mm x width 55mm x height 40mm	Length 42mm x width 50mm x height 37mm	

**BD-D751/D754**  
**YELLOW EMERGENCY STOP**  
**SWITCH WARN SIGN**



**Product Features**

- Made of strong and durable reinforced nylon.
- Easy and quick to install to warn operations effectively.

**Product Selection**

Model	Dia.	Dia. of installing hole
BD-D751	46mm	22mm
BD-D752	39mm	
BD-D753	60mm	25mm
BD-D754	66mm	

**BD-D761/D763**  
**BUTTON BOX DUST PLUG**



**Product Features**

- The main body is made from engineering plastic PC.
- Flame-retardant and fire-resistant shell, cold and high temperature resistance, waterproof, impact resistance, insulation and leakage prevention.

**Product Selection**

Model	Description
BD-D761	Suitable for push button max Dia. 16mm
BD-D762	Suitable for push button max Dia. 22mm
BD-D763	Suitable for push button max Dia. 30mm

**BD-D771/D772**  
**BUTTON WARNING SIGN**



**Product Features**

- The main body is made from engineering plastic PC.
- Flame-retardant and fire-resistant shell, cold and high temperature resistant, impact resistant.

**Product Selection**

Model	Description
BD-D771	Length 30mm x width 46mm
BD-D772	Length 30mm x width 46mm

**BD-D781/D782**  
**BUTTON MOUNTING WRENCH**



**Product Features**

- The main body is made from engineering plastic PC.
- It can improve installation efficiency and reduce labor intensity of installation workers.

**Product Selection**

Model	Description
BD-D781	Dia. of installation: 22mm
BD-D782	Dia. of installation: 22mm

Unit: mm

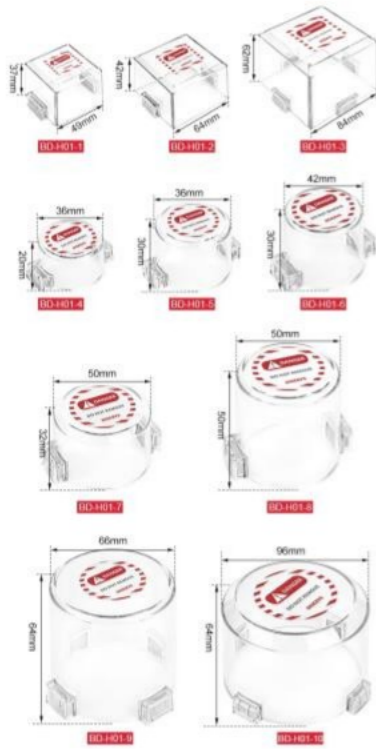

**BD-DS01**  
 BATTERY ISOLATOR  
 BRACKET LOCKOUT

Unit: mm



BD-DS01



- cover can be quickly installed and taken out to prevent accidental touch.
- Scope of application: buttons, knobs, control switches, etc. on the magnetic panel.
  - Material: PC.

**Product Selection**

Model	Dimensions inside	Application
BD-H01-1	45mm*35mm*2mm	
BD-H01-2	60mm*40mm*2mm	
BD-H01-3	79mm*59.5mm*2mm	
BD-H01-4	32mm*18mm*2mm	
BD-H01-5	32mm*18mm*2mm	
BD-H01-6	32mm*18mm*2mm	
BD-H01-7	46mm*30mm*2mm	
BD-H01-8	45mm*47.5mm*2mm	
BD-H01-9	61mm*61.5mm*2mm	
BD-H01-10	90mm*61mm*3mm	

**Product Features**

- This locking brackets is manufactured with 2mm stainless steel and powder coated for identification. The size of the bracket is 70x55x50mm.
- For battery isolation use red, For starter isolation use yellow, Optional for either battery or starter use blue
- Locking brackets are designed to fit switches without the removal of the switch and cables.
- This enables the switch to be locked out, protects the personnel and the vehicle from unauthorized start up.

**Product Selection**

Model	Dimensions inside	Application
BD-DS01	70mm*55mm*50mm	



# ALVE LOCKOUT



**BD-F01/F01D/F02**  
**ADJUSTABLE BALL VALVE**  
**LOCKOUT**

Unit: mm

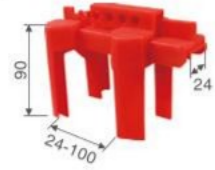

BD-F01



BD-F01D



BD-F02

**BD-F03/F03N/F04**  
**STANDARD BALL VALVE**  
**LOCKOUT**

Unit: mm

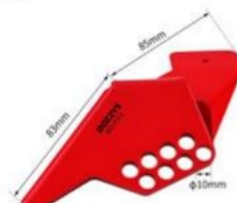

BD-F03



BD-F03N

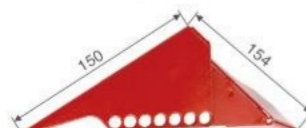

BD-F04-1

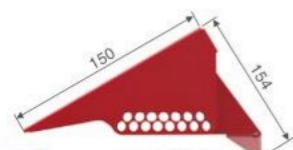

BD-F04-2

**Product Features**

- Made of polypropylene PP.
- It can be locked with a safety padlock with a Dia. of the lock beam ≤ 9mm.
- Color red, other colors to order.

**Product Selection**

Model	Description	Application
BD-F01	suitable for DN8-DN50 valve 0.5" to 2.5" (13-64mm)	
BD-F01D	suitable for DN50-DN100 valve	
BD-F02	suitable for DN50-DN200 valve 2" to 8" (50-200mm)	

**Product Features**

- BD-F03 and BD-F04 are made of steel plate, the surface is sprayed with high temperature, not easy to rust; BD-F03N is made of polypropylene Pp material;
- Dedicated to quarter-turn ball valves in locked closed state;
- Color red, other colors to order. Chinese and English warning labels are available.

**Product Selection**

Model	Description	Application
BD-F03	suitable for DN8-DN50 valve 0.25" to 1" (6.35-25.4mm)	
BD-F03N		
BD-F04-1	suitable for DN50-DN200 valve 1.5" to 3" (38.1-76.2mm)	
BD-F04-2		

**BD-F05/F06/F07**  
**ADJUSTABLE BALL VALVE**  
**LOCKOUT**

Unit: mm



BD-F05



BD-F05A



BD-F06



BD-F06A



BD-F07

**Product Features**

- Made of high temperature resistant, high strength polypropylene PP.
- Lock out double roll valves.
- With auxiliary rear gear parts, locked heightening extended ball valve.

**Product Selection**

Model	Description	Application
BD-F05	suitable for DN8-DN50 valve	
BD-F05A	suitable for DN8-DN50 valve, with auxiliary rear gear parts	
BD-F06	suitable for DN50-DN70 valve	
BD-F06A	suitable for DN50-DN70 valve, with auxiliary rear gear parts	
BD-F07	suitable for DN70-DN200 valve	

**BD-F08/F08P**  
**ADJUSTABLE FLANGE BALL**  
**VALVE LOCKOUT**

Unit: mm



BD-F08

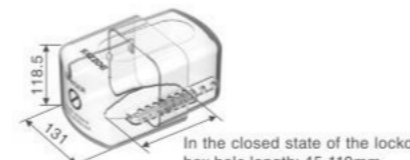

BD-F08P

**Product Features**

- Made of polypropylene PP;
- It can be locked with a safety padlock with a Dia. of the lock beams 9mm;
- F08 color red, F08P transparent color, other colors need to be ordered.

**Product Selection**

Model	Description	Application
BD-F08	suitable for DN8-DN125 valve	
BD-F08P	suitable for DN15-DN200 valve	

VALVE LOCKOUT

VALVE LOCKOUT



FLOURISHING YOUR BUSINESS

**BD-F09/F09X**  
**ADJUSTABLE BALL VALVE LOCKOUT**

Unit: mm

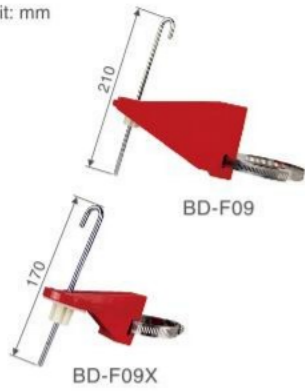

**Product Features**

- Made from zinc alloy, surface treatment by high temperature spray plastic, not easy to rust.
- Used to lock industrial ball valve.
- Maximum padlock Dia.: 7mm.
- Color: red, other colors need to be customized.
- Suitable for all ball valves with a thickness of ≤10mm.

**Product Selection**

Model	Description	Application
BD-F09	Size: 163x56x92mm, suitable for handle length ≤150mm	
BD-F09X	Size: 108x39x56mm, suitable for handle length ≤150mm	

**BD-F10**  
**FLANGE BALL VALVE LOCKOUT BAG**

Unit: mm



**Product Features**

- The bag body is made of PC wear-resistant material, which is durable in harsh environment.
- The fixed belt is made of PP, which makes the lock bag more stable and effective.
- 3pcs safety padlocks (shackle Dia. ≤7mm) can lock on at the same time.
- The lock bag comes with a handle storage bag to store the matching locks, which is convenient and efficient to use, can prevent the locks from being lost.

**Product Selection**

Model	Description	Application
BD-F10	Valve head Dia. ≤30mm	

**BD-F11(T)~F15(T)**  
**STANDARD GATE VALVE LOCKOUT**

Unit: mm



BD-F11~F15



BD-F11T~F15T

**Product Features**

- BD-F11~F15 are made of ABS, BD-F11T~F15T are made of PC;
- Dedicated to locking gate valves with a stem Dia. (handwheel Dia.) of 25mm-330mm;
- It can be locked with a safety padlock with a Dia. of the lock beams ≤7mm;
- Color red or clear, other colors to order. Chinese and English warning labels are available.

**Product Selection**

Model	Valve rod Dia. (Wheel dia)	Hole dia	Inner Height	Application
BD-F11/F11T	25-64mm(1"-2.5")	19mm	28mm	
BD-F12/F12T	64-127mm(2"-5")	44mm	35mm	
BD-F13/F13T	127-165mm(5"-6.5")	62mm	40mm	
BD-F14/F14T	165-254mm(6.5"-10")	88mm	60mm	
BD-F15/F15T	254-330mm(10"-13")	105mm	60mm	

**BD-F11A~F15X**  
**STANDARD GATE VALVE LOCKOUT**

Unit: mm



**Product Features**

- Made from imported DuPont engineering plastics.
- The different size semicircle design, two parts can be combined into one when storing and carrying, reduce a half volume.
- Locked by 2-4 pcs padlocks, locked shackle Dia. ≤7mm.
- Color: red, other colors need to be customized. Label can be customized.

**Product Selection**

Model	Valve rod Dia. (Wheel dia)	Hole dia	Inner Height	Application
BD-F11A	25-64mm(1"-2.5")	19mm	30mm	
BD-F12A	64mm-127mm(2.5"-5")	44mm	35mm	
BD-F13A	127-165mm(5"-6.5")	62mm	50mm	
BD-F14A	165-254mm(6.5"-10")	90mm	60mm	
BD-F15A	254-330mm(10"-13")	105mm	65mm	
BD-F15Plus	330-450mm(13"-18")	125mm	60mm	
BD-F15B	450-600mm(18"-24")	125mm	65mm	

**BD-F16**  
**ADJUSTABLE VALVE LOCKOUT**

Unit: mm



BD-F16

**Product Features**

- Made from polypropylene PP.
- Lock range can be adjusted. Lock the hand wheel Dia. 25mm-165mm(1"-6.5") valve.
- Locked by padlock. padlock's shackle Dia. max 7mm.
- Color: red, other colors need to be customized. Tagout is available.

**Product Selection**

Model	Valve rod Dia. (Wheel dia)	Application
BD-F16	25-165mm(1"-6.5")	

**BD-F17**  
**BUTTERFLY HANDLE BALL VALVE LOCKOUT**

Unit: mm



BD-F17

**Product Features**

- Made of high-strength glass resin PC.
- Can handle ball valves can be safely locked.
- Can lock four safety padlocks with shackle diameters ≤8mm at the same time.

**Product Selection**

Model	Valve rod Dia. (Wheel dia)	Application
BD-F17	6.3-25mm(1/4"-1")	

VALVE LOCKOUT

VALVE LOCKOUT

**BD-F20**  
**ADJUSTABLE BUTTERFLY VALVE LOCKOUT**

Unit: mm

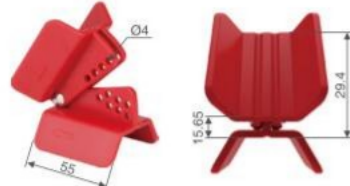

BD-F20

**Product Features**

- Made from Nylon PA +ABS.
- Suitable for butterfly valve.
- Use with 4mm Dia. cable lockout.

**Product Selection**

Model	Description	Application
BD-F20	Adjustable angle: 15° - 36°	

**BD-F21**  
**BUTTERFLY VALVE LOCKOUT**

Unit: mm

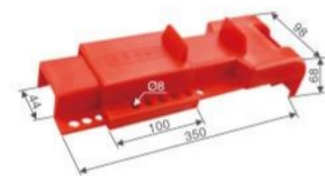

BD-F21

**Product Features**

- Made from polypropylene PP.
- Locked by padlock, locked shackle Dia. max 7mm.
- Color: Red, other colors can customized.

**Product Selection**

Model	Description	Application
BD-F21	Suitable for butterfly valves with handle width: 8mm-42mm	

**BD-F22**  
**BUTTERFLY VALVE LOCKOUT**

Unit: mm

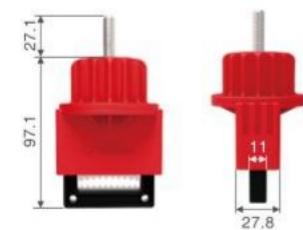

BD-F22

**Product Features**

- Made from polypropylene PP.
- Suitable for some butterfly valve.
- Color: Red, other colors can customized.

**Product Selection**

Model	Description	Application
BD-F22	Valve rod Dia.: width≤42mm, Max opening≥14.5mm; height: 5mm-35mm	

**BD-F31(X)~F35(X)**  
**UNIVERSAL VALVE LOCKOUT**

Unit: mm



BD-F31/31X



BD-F32/32X



BD-F33/33X

BD-F34/34X



BD-F35/35X

**Product Features**

- Made from engineering plastic strengthened nylon PA and stainless steel.
- Fit the new open-ended clamp over the closed ring, used to lock out the large handle,
- Also can used to Large leverage ,T-shape handles and other hard-to-secure mechanical devices.
- Cable accessories can be used 3.2mm (1/8")stainless steel metal cable coated by PVC.
- Suitable for gate valve, ball valve, butterfly valve and so on.

**Product Size**

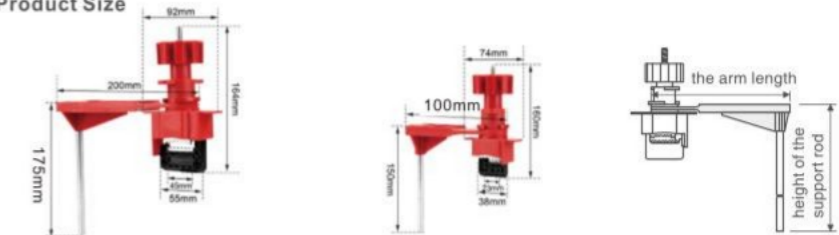

BD-F31~F35	BD-F31X~F35X
For maximum handle width: 40mm Max handle thickness: 28mm	For maximum handle width: 23mm Max handle thickness: 14mm
Arm length: 200mm height of the support rod: 175mm	Arm length: 140mm height of the support rod: 150mm

**Product Selection**

Model	Description	Application
BD-F31/F31X	Single Arm Universal valve Lockout/ Small Single Arm Universal valve Lockout	
BD-F32/F32X	Single Arm Universal valve Lockout/ Small Single Arm Universal valve Lockout	
BD-F33/F33X	Universal Valve lockout/ Small Universal Valve lockout	
BD-F34/F34X	Universal Butterfly Valve lockout/ Small Universal Butterfly Valve lockout	
BD-F35/F35X	Universal Valve lockout/ Small Universal Valve lockout	

**BD-F36**  
**MULTI-FUNCTION VALVE LOCKOUT**

Unit: mm



BD-F36-1  
Strip  
compression  
block

BD-F36-2  
Circular  
compression  
block

**Product Features**

- The lock body is made of engineering plastic PC. Toothed carbon steel sheet and stainless steel screws.
- With self-contained tightening screw, easy to lock by yourself without tools.
- 192mm (height) \*94mm (width) \*32mm (thickness) (Not include Screw rod length)
- Applicable locking range: 31mm-100mm.
- Maximum padlock Dia.: 7mm.

**Product Selection**

Model	Valve rod Dia. (Wheel dia)	Application
BD-F36-1	For Butterfly Valve	
BD-F36-2	For Valve	

VALVE LOCKOUT

VALVE LOCKOUT

**BD-F37**  
**PULL-HANDLE BUTTERFLY VALVE LOCKOUT**

Unit: mm

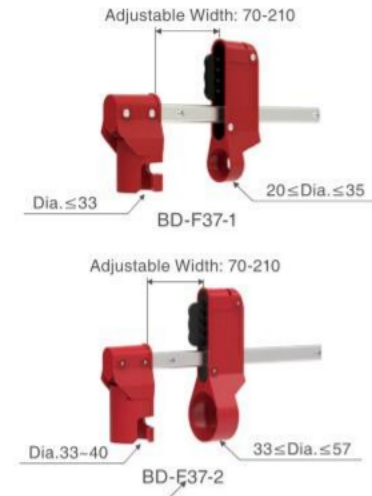

**Product Features**

- Made from Alloy aluminum and engineering plastic.
- 4 padlocks can be locked at the same time.

**Product Selection**

Model	Description	Application
BD-F37-1	valve rod diameters≤33mm, 20mm≤valve handle diameters≤35mm	
BD-F37-2	Between 33 and 40 diameters 33mm≤valve handle diameters≤57mm	

**BD-F41~F44**  
**PLUG VALVE LOCKOUT**

Unit: mm



BD-F41/F42



BD-F43/F44

**Product Features**

- The lock is made of engineering plastic PP and stainless steel locking braid.
- Suitable for manual plug valves with Dia. of 1"-8".
- Effectively applicable to such difficult-to-lock valves.
- Durable and vandal-proof. Compact size and easy to use.

**Attention**

**Select the right size**

Select the right plug lockout by measuring the size of A and B (Stem Dia.)

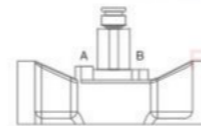

If the operating wrench and the valve stem plane above the clamp can still be completely engaged, the base and clamp of the plug valve lockout can be leave on the valve for standby . At this time, just remove the plug valve cover and padlock to open the valve.

**Product Selection**

Model	Valve stem Dia. (hand wheel Dia.)	Application
BD-F41	≤22mm	
BD-F42	23-34mm	
BD-F43	44-52mm	
BD-F44	55-62mm	

**BD-FL01/02/03**  
**BLIND FLANGED LOCKOUT DEVICE**

Unit: mm

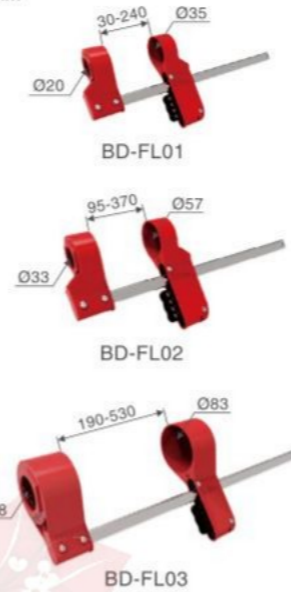

**Product Features**

- Made from Alloy aluminum and engineering plastic.
- 4 padlocks can be locked at the same time.
- Durable powder spraying aluminum clamp+hardened steel sliding strip, ensuring usage no worries.

**Product Selection**

Model	Description	Application
BD-FL01	Suitable for flange blind plate width between 30-240mm	
BD-FL02	Suitable for flange blind plate width between 95-370mm	
BD-FL03	Suitable for flange blind plate width between 190-530mm	

**BD-D72/D73**  
**ENTRY HOLE LOCKOUT BAG**

Unit: mm



**Product Features**

- Made from wear resisting polyester cloth
- Used with 5 meters cable lockout, it can be locked in many ways.
- Print warning sign on surface.

**Product Selection**

Model	Description	Application
BD-D72	Cable lockout need to be bought separately	
BD-D73-1	Ventilated hood with elastic confined space	
BD-D73-2	Locked in ventilated hood confined space	
BD-D73-3		

VALVE LOCKOUT

VALVE LOCKOUT

**BD-F38  
 VALVE LOCKOUT**

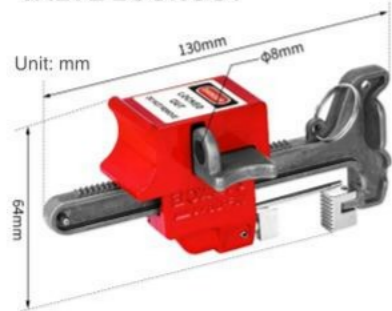

BD-F38

**Product Features**

- Made of aluminum alloy;
- Made of PA66+20%GF.
- No remove the handle type ball valve lock to prevent the valve from being opened :

**Product Selection**

Model	Description	Application
BD-F38	Suitable for DN8-DN100 right angle handle valve	

**FPQ1  
 VALVE LOCKOUT**

Unit: mm

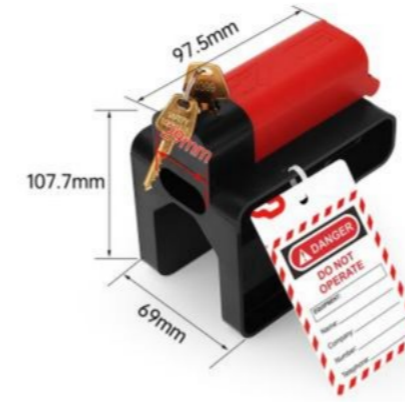

BD-FPQ1

**Product Features**

- Plastic parts: ABS, embedded copper nuts and steel screws;
- Suitable for locking long-handled ball valves;
- With self-locking, replaces the traditional locking method. Installation process simple and quick.

**Product Selection**

Model	Description	Application
BD-FPQ1	Suitable for DN100 right angle handle valve	

**FP1/FP2/FP3/FP4  
 SELF-LOCKING VALVE  
 LOCKOUT**



**Product Features**

- Made of PA+ABS material;
- Dedicated to locking gate valves with a stem Dia. (handwheel Dia.) of 25mm-254mm;
- With self-locking, replaces the traditional locking method. Installation process simple and quick.

**Product Selection**

Model	Valve rod dim. (Wheel dim.)	Hole dim	Inner height	Application
FP1	25-64(1"-2.5")	29	38	
FP2	64-127(2.5"-5")	44	47	
FP3	127-165(5"-6.5")	63	45	
FP4	165-254(6.5"-10")	90	58	

**BD-F51  
 BUC VALVE LOCKOUT**

Unit: mm



BD-F51

**Product Features**

- Lock the BUC hand valve;
- Lock body material: ABS
- Installation process simple and quick.

**Product Selection**

Model	Description	Application
BD-F51	BUC hand valves up to Dn12	



**FP16**  
 SELF-LOCKING  
 HANDLE VALVE LOCKOUT



BD-FP16

**Product Features**

- Made from PA+ABS;
- Lock range can be adjusted.
- With self-locking, replaces the traditional locking method. Installation process simple and quick.

**Product Selection**

Model	Description	Application
BD-FP16	25-135mm(1-"6.5")	

**PNEUMATIC LOCKOUT**



**BD-Q01**  
**PNEUMATIC QUICK-DISCONNECT LOCKOUT**

Unit: mm

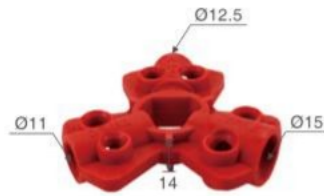
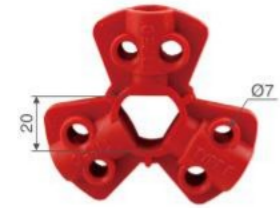

BD-Q01

**Product Features**

- Made from impact resistant engineering plastic nylon PA.
- No need to install and straight interlock valve, can be isolated pneumatic power, lower cost, more convenient.
- Locks can be connected with external threaded joints to isolate equipment from all compressed air sources.
- Hole in the center of device allows for permanent storage on an air hose and a loop on
- the side can be used to hang the hose and lockout device.
- Can be equipped with padlocks, lock shackle Dia. of 6.4mm (1/4") or 7.1mm (9/32").

**Product Selection**

Model	Description	Application
BD-Q01	Fitted with 6.4mm, 9.5mm, 12.7mm screwed joint	

**BD-Q11**  
**AIR SOURCE LOCKOUT**

Unit: mm

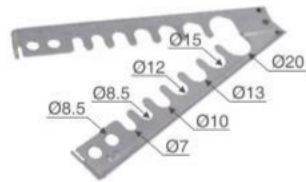

BD-Q11

**Product Features**

- Made from 304 stainless steel.
- Applied to the fitting and prevents it from being reconnected to the pressurized air source.
- 2 padlocks can be locked with ≤7mm shackle Dia.
- Size: Width 35mm x Length 196mm x Thickness 3mm
- Used together with safety padlocks and safety hasps.

**Product Selection**

Model	Description	Application
	Suitable for air supply joints with a Dia. of 7mm - 20mm	

**BD-Q12**  
**AIR SOURCE LOCKOUT**

Unit: mm



BD-Q12

**Product Features**

- Made of 304 stainless steel.
- The diameter of the air source connector is 6.7~15mm.
- Prevent the Air Source connector from being connected to a high voltage source.
- It can be locked with 2 safety padlocks with shackle diameter ≤8mm.

**Product Selection**

Model	Description	Application
BD-Q12	Suitable for Air Source connector diameter 6.7~15mm	

**BD-Q21(T)~Q24(T)**  
**CYLINDER TANK LOCKOUT**

Unit: mm



BD-Q21~Q24



BD-Q21T~Q24T

**Product Features**

- Made from engineering plastic ABS. (Adding "T" after the product part code means transparent, it is made of PC material)
- Used to lock out the tank, including the propane tanks on forklifts trucks and stand alone propane tanks
- Easy to avoid unauthorized operation of the valve stem.

**Product Selection**

Model	Description	Application
BD-Q21/Q21T	Suitable for hole Dia. less than 30mm, inner Dia. 80mm, inner height 35.2mm	
BD-Q22/Q22T	Suitable for hole Dia. less than 40mm, inner Dia. 101mm, inner height 26mm	
BD-Q23/Q23T	Suitable for hole Dia. less than 30mm, inner Dia. 61mm, inner height 25mm	
BD-Q24/Q24T	Suitable for hole Dia. less than 40mm, inner Dia. 60mm, inner height 45mm	

**BD-Q31**  
**CYLINDER TANK LOCKOUT**

Unit: mm



BD-Q31

**Product Features**

- Made from engineering plastic PP.
- Prevents access to the main cylinder valve without authorization .
- No need to match your lockout device to varying Dia. and threads of cylinder caps.
- Can be used for the maximum Dia. 80mm of the neck ring.
- Can be locked with 3 padlocks, lock shackle Dia. ≤ 7mm.

**Product Selection**

Model	Description	Application
BD-Q31	Max 80mm of the neck ring	

**BD-Q110**  
**CYLINDER VALVE LOCK**

Unit:mm  
 the size of the hole  
 Ø7, can be customized



BD-Q110

**Product Features**

- Made of High density polyethylene(HDPE).
- Prevent chemical substances from being discharged into the environment and prevent dirt particles from polluting chemicals.
- Can be locked with 3 padlocks, lock shackle Dia. ≤ 7mm.

Model	Description	Application
BD-Q110	oil drum hole with 82-88mm outer Dia.	

**BD-Q120**  
**OIL DRUM LOCKOUT**

Unit:mm

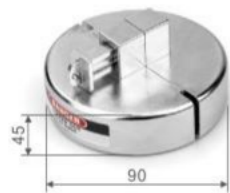

BD-Q120

**Product Features**

- Made of corrosion resistance of aluminum alloy.
- lock the Items of the barrel safety.
- Installed around the barrel plug flange without risk of cross threading
- Can be locked with padlocks, lock shackle Dia. < 7mm.

**Product Selection**

Model	Description	Application
BD-Q120	oil drum hole with 72-85mm outer Dia.	

**BD-Q130**  
**OIL DRUM LOCKOUT**

Unit:mm



**Product Features**

- Main body made of PA66+20%GF,Black sealing ring is nitrile rubber .
- Protect the Items of the barrel safety.
- Butterfly nut rotates clockwise ,and expand the gasket, forming a liquid and gas tight seal.
- Can be locked with padlocks, lock shackle Dia. ≤ 7mm.

**Product Selection**

Model	Description	Application
BD-Q130-1	BD-Q130-1:Small sealing ring for oil drum hole with 50-60mm outer Dia..	
BD-Q130-2	BD-Q130-2: Large sealing ring for oil drum hole with 60-70mm outer Dia..	

**CABLE LOCKOUT**

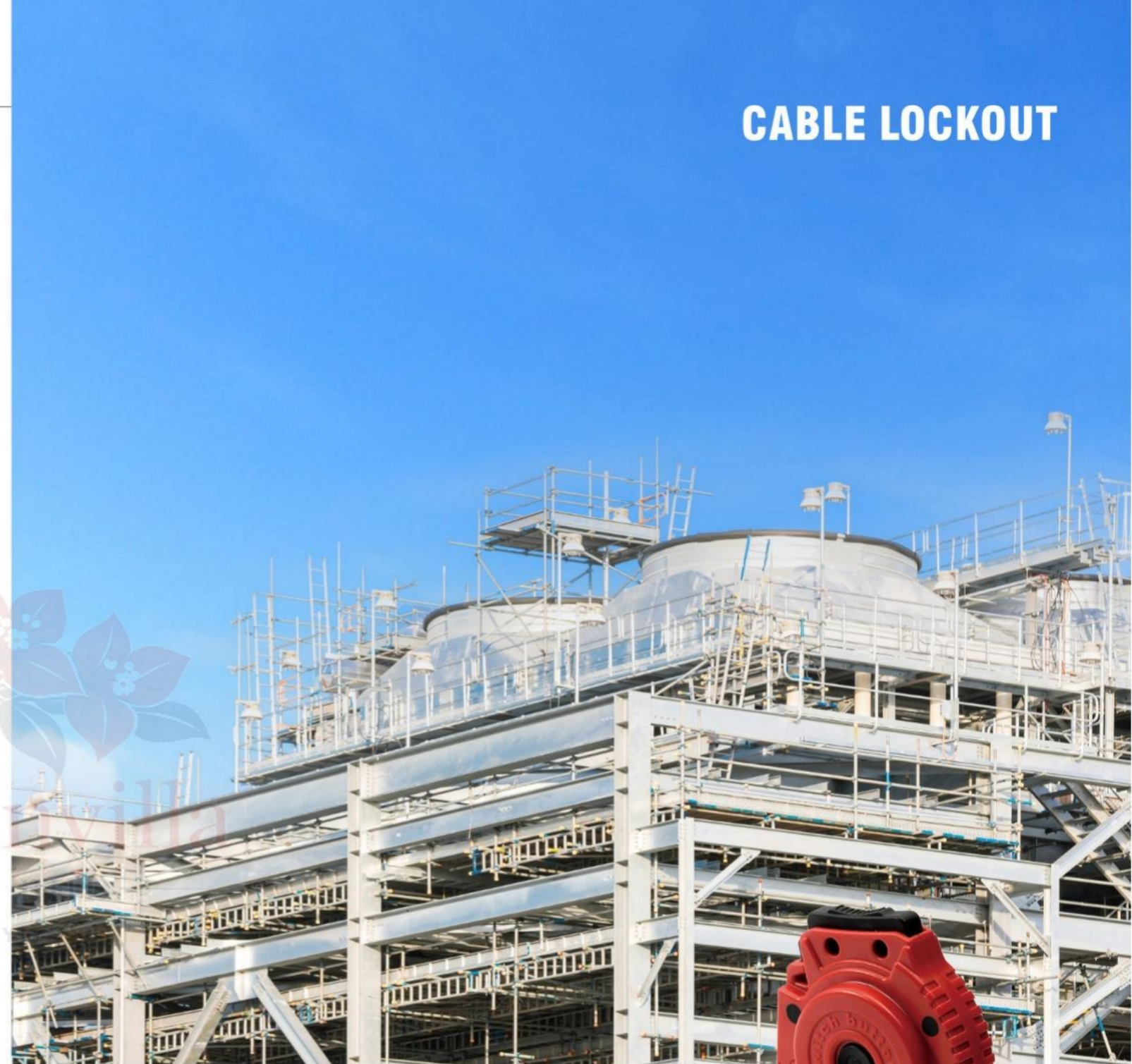

**BD-L01**  
**MULTIPURPOSE CABLE LOCKOUT**

Unit:mm



BD-L01

**BD-L02**  
**MULTIPURPOSE CABLE LOCKOUT**

Unit:mm

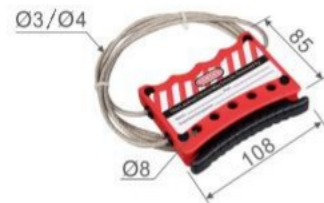

BD-L02

**BD-L11**  
**MULTIPURPOSE CABLE LOCKOUT**

Unit:mm



BD-L11

**Product Features**

- Made from impact resistant engineering plastic nylon PA, can be customized other colors.
- Used stainless steel cable, the outer layer of cable is made from anti-UV PVC.
- The cable can be customized with different length and colors.
- Locked with one padlock, lock shackle Dia. is less than 7mm.

**Product Selection**

Model	Description	Application
BD-L01	dia 3.5mm x length 2.4m	

**Product Features**

- Made from engineering plastic ABS.
- Used stainless steel cable, the outer layer of cable is made from anti-UV PVC.
- Innovative self-locking function, the cable lock is self-locking when it is not operated, to ensure that the cable is not stretched randomly.
- Permanently write labels ( Chinese English or other languages can be customized ) to identify the operator.
- Locked with 5 padlocks, lock shackle Dia. is less than 7mm.

**Product Selection**

Model	Description	Application
BD-L02-4	dia 4mm x length 1.8m,	
BD-L02-3	dia 3mm x length 1.8m	

**Product Features**

- Made from impact resistant engineering plastic PC, other colors can be customized.
- used stainless steel cable the outer layer of cable is made from anti-UV PVC. the cable can be customized with different length and colors.
- Stronger cable, more secure locking, easy to open and lock, and more convenient to use.
- Permanently write labels ( Chinese, English or other languages can be customized ) to identify the operator.
- Locked with 4 padlocks, lock shackle Dia. is less than 7mm.

**Product Selection**

Model	Description	Application
BD-L11-4	dia 4mm x length 1.8m,	
BD-L11-6	dia 6mm x length 1.8m	

**BD-L12**  
**ADJUSTABLE CABLE LOCKOUT**

Unit:mm



BD-L12

**BD-L21**  
**ECONOMIC CABLE LOCKOUT**

Unit:mm

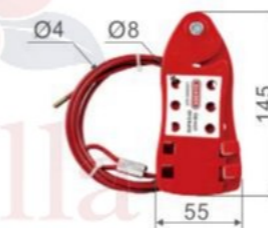

BD-L21

**BD-L22**  
**ADJUSTABLE CABLE LOCKOUT**

Unit:mm

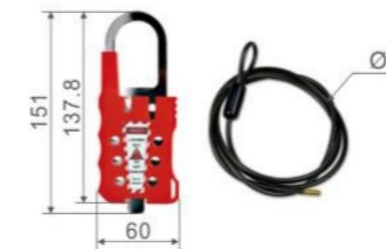

BD-L22

**Product Features**

- Made of PC &ABS.
- It's suitable for all turbine ball valves.
- It's used to lock the industrial ball valve in the closed state to prevent misuse.
- Suitable for padlocks with lock shackle less than 7mm.
- Colour: red. other colors can be customize .

**Product Selection**

Model	Description	Application
BD-L12-1	Insulated cable: dia 3.2mm x length 2.5m	
BD-L12-2	Steel cable: dia 5mm x length 2.5m	

**Product Features**

- Made from impact resistant engineering plastic nylon PA, can be customized other colors.
- Used stainless steel cable, the outer layer of cable is made from anti-UV PVC.
- The cable can be customized with different length and colors.
- Locked with 6 padlocks, lock shackle Dia. is less than 7mm.

**Product Selection**

Model	Description	Application
BD-L21	dia 4mm x length 2m	

**Product Features**

- Made of ABS &PC alloy.
- Used stainless steel cable ,the outer layer of cable is made from anti-UV PVC.
- Allow 6 padlocks with lock shackle less than 7mm.
- Colour: red.

**Product Selection**

Model	Description	Application
BD-L22	dia 5mm x length 1.8m	

**BD-L31/L31A**  
**WHEEL TYPE CABLE LOCKOUT**

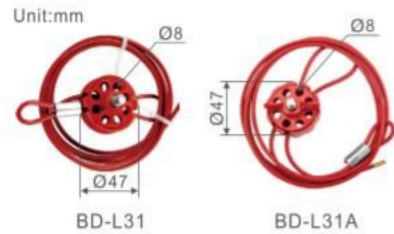

**Product Features**

- Made from impact resistant engineering plastic nylon PC .
- Used stainless steel cable, the outer layer of cable is made from anti-UV PVC.
- Cable can be customized other colors. (Red,yellow,blue,green)
- The cable can be customized with different length and colors.
- Locked with several padlocks, lock shackle Dia.is less than 7mm.
- This cable lockout is an ideal device for locking cable device.

**Product Selection**

Model	Description	Application
BD-L31	dia 4mm x length 2m	
BD-L31A		

**BD-L32**  
**WHEEL TYPE CABLE LOCKOUT**



BD-L32

**Product Features**

- The lock body is made of engineering plastic reinforced nylon and copper fittings.Other colors can be customized.
- Used stainless steel cable, the outer layer of cable is made from anti-UV PVC.
- The cable can be customized with different length and colors.
- Comes with a lock handle, easy to use.
- Locked with several padlocks, lock shackle Dia. is less than 7mm.

**Product Selection**

Model	Description	Application
BD-L32	dia 4mm x length 2m	

**BD-L41**  
**AUTOMATIC RETRACTABLE CABLE LOCKOUT**



BD-L41

**Product Features**

- Made of Polycarbonate Plastic(PC).
- Used stainless steel cable, the outer layer of cable is made from anti-UV PVC.
- Automatic retraction, press the winding switch button, the cable can automatic retract; maneuverable, portable, durable.
- Allow 2 padlocks with lock shackle less than 7mm.

**Product Selection**

Model	Description	Application
BD-L41	dia 1.5mm x length 2.2m	

**BD-L42**  
**MINI CABLE LOCKOUT**

Unit:mm



BD-L42

**Product Features**

- Made from impact resistant engineering plastic nylon PA.
- Used stainless steel cable, the outer layer of cable is made from anti-UV PVC.
- Black parts: When push it up, the cable will be unlocked; When push it down, the cable will be locked. With "LOCK OUT" on red parts for warning.
- The cable can only be tightened up after locking, more convenient to operate.
- Label can be customized.
- With 6mm and 8mm Dia. lock holes, suitable for different shackles.

**Product Selection**

Model	Description	Application
BD-L42-300mm	dia 1.5mm x length 0.3m,	
BD-L42-500mm	dia 1.5mm x length 0.5m	

**BD-L61**  
**SIMPLE CABLE LOCKOUT**

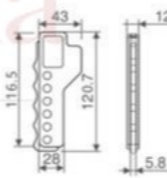

BD-L61

**Product Features**

- The lockout body is made of engineering plastic nylon PA
- The outer layer of the cable is made of UV-resistant PVC, and the inner material is divided into two materials: insulation and metal (stainless steel);
- Customizable labels.(Chinese,English or multi-language customization)

**Product Selection**

Model	Description	Application
BD-L61-3	dia 3mm x length 1.8m, Metal cable	
BD-L61-4	dia 4mm x length 1.8m, Metal cable	
BD-L61-5	dia 5mm x length 2.4m, Insulated cable	

**BD-AL61**  
**SIMPLE ALUMINUM CABLE LOCKOUT**

Unit:mm

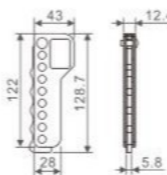

**Product Features**

- The lock body is made of painted die-cast aluminum;
- It can be locked with 8 safety padlocks with shackle Dia.≤7mm;
- Colour: lacquered silver or lacquered red.

**Product Selection**

Model	Description	Application
BD-AL61-3	dia 3mm x length 1.5m,	
BD-AL61-4	dia 4mm x length 1.5m	

CABLE LOCKOUT

**LS1-P041/LS1-P061**

**CABLE LOCKOUT**

Unit:mm

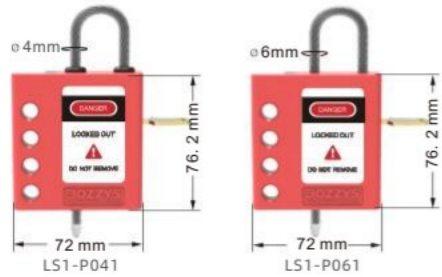

**Product Features**

- Lock body: PA+ABS injection molding, cylinder made of brass.
- Stainless steel cable, outer layer made of UV-resistant PVC.
- Integrates cable lock and key management functions, reserved with four shared locking holes. Innovates in aspects such as portability and reducing the need for lock storage during lockout/tagout procedures.

**Product Selection**

Model	Description	Application
LS1-P041	Cable size dia 4mmx1.8m	
LS1-P061	Cable size dia 6mmx1.8m	

**LM1-M041/LM1-M061**

**CABLE LOCKOUT**



**Product Selection**

- Housing: one-piece high-strength steel, painted surface; cable: stainless steel with PVC. Cylinder made of brass.
- After locking, cable length can be adjusted unidirectionally (pull down the cable); conventional cable locks have fixed length and cannot adapt to various distances.
- Cable diameter:  $\Phi$ 4mm or  $\Phi$ 6mm; length range 0.35-2 meters.

**Product Features**

Model	Description	Application
LM1-M041	Cable size dia 4mmx1.9m	
LM1-M061	Cable size dia 6mmx1.9m	

**Product Selection**

LM1-M041	LM1-M044	LM1-M047	LM1-M061	LM1-M064	LM1-M067

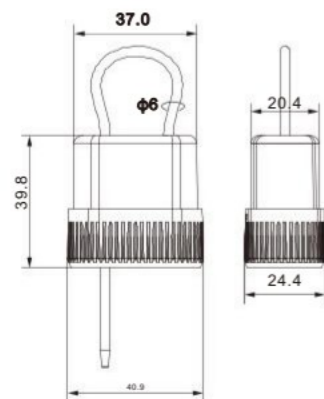

**BD-SL31**  
**STAINLESS STEEL**  
**CABLE LOCKOUT**

Unit:mm

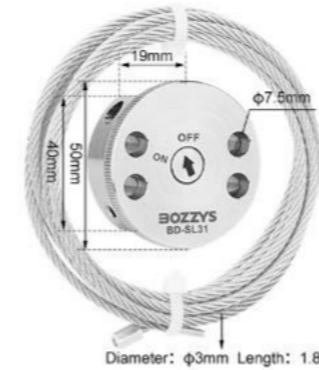

Diameter:  $\Phi$ 3mm Length: 1.8m

BD-SL31

**Product Features**

- The Multipurpose Stainless steel Cable Lockout is constructed from 316-grade stainless steel and includes a 1.8m stainless steel cable. with rust and corrosion resistance. It is suitable for a variety of locking applications and can be used in a variety of locations.

**Product Selection**

Model	Description	Application
BD-SL31	Suitable for single or multiple parallel valve lockouts.	

**BD-SL61**  
**SIMPLE STAINLESS STEEL**  
**CABLE LOCKOUT**

Unit:mm

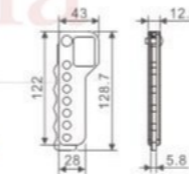

BD-SL61

**Product Features**

- The lock body is made of die-cast stainless steel.
- It can be locked with 7 safety padlocks with shackle Dia.  $\leq$ 7mm.

**Product Selection**

Model	Description	Application
BD-SL61-3	dia 3mm x length 1.5m,	
BD-SL61-4	Description dia 4mm x length 1.5m,	

**BD-L62**  
**CABLE LOCKOUT**

Unit:mm

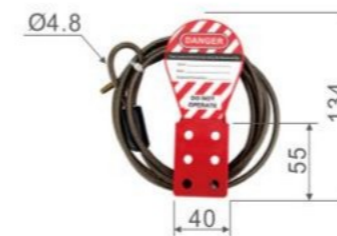

BD-L62

**Product Features**

- Made of PC material.
- Used stainless steel cable, the outer layer of cable is made from anti-UV PVC.
- Allow 6 padlocks with lock shackle less than 7mm.
- Colour: red, other colors need to be customized.

**Product Selection**

Model	Description	Application
BD-L62	dia 4.8mm x length 1.8m	

CABLE LOCKOUT

# LOCKOUT STATION



## BD-B100 SERIES INTEGRATED LOCKOUT STATION

Unit:mm

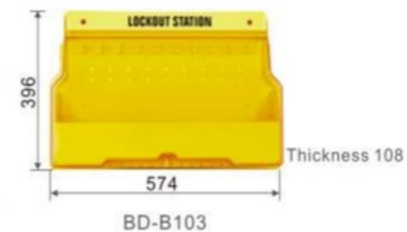

### Product Introduction

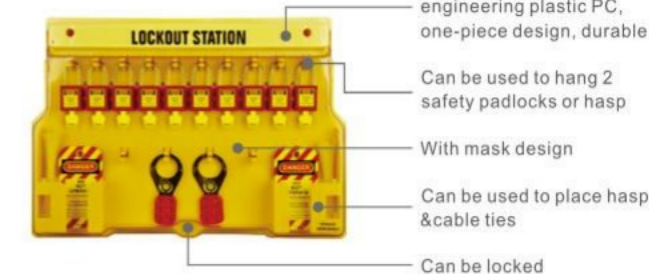

### Product Selection

Model	Description
BD-B101	There are 5 hook positions, each of which can accommodate up to 2 padlocks and 4 hasps, and can also accommodate several types of lockouts, tags, cable ties, etc.
BD-B102	There are 14 hook positions, each of which can accommodate up to 2 padlocks and 4 hasps, and can also accommodate several types of lockouts, tags, cable ties, etc.
BD-B103	There are 8 hook positions, each of which can accommodate up to 2 padlocks and 4 hasps, and can also accommodate several types of lockouts, tags, cable ties, etc.
BD-B104	There are 8 hook positions, each of which can accommodate up to 2 padlocks and 4 hasps, and can also accommodate several types of lockouts, tags, cable ties, etc.
BD-B105	There are 4 hook positions, each of which can accommodate up to 2 padlocks and 4 hasps, and can also accommodate several types of lockouts, tags, cable ties, etc.
BD-B1100	There are 16 hook positions, each of which can accommodate up to 2 padlocks and 4 hasps, and can also accommodate several types of lockouts, tag cable ties, etc. (This model is a combination of BD-B103 and BD-B104)

**BD-B200 SERIES  
 COMBINED LOCKOUT STATION**

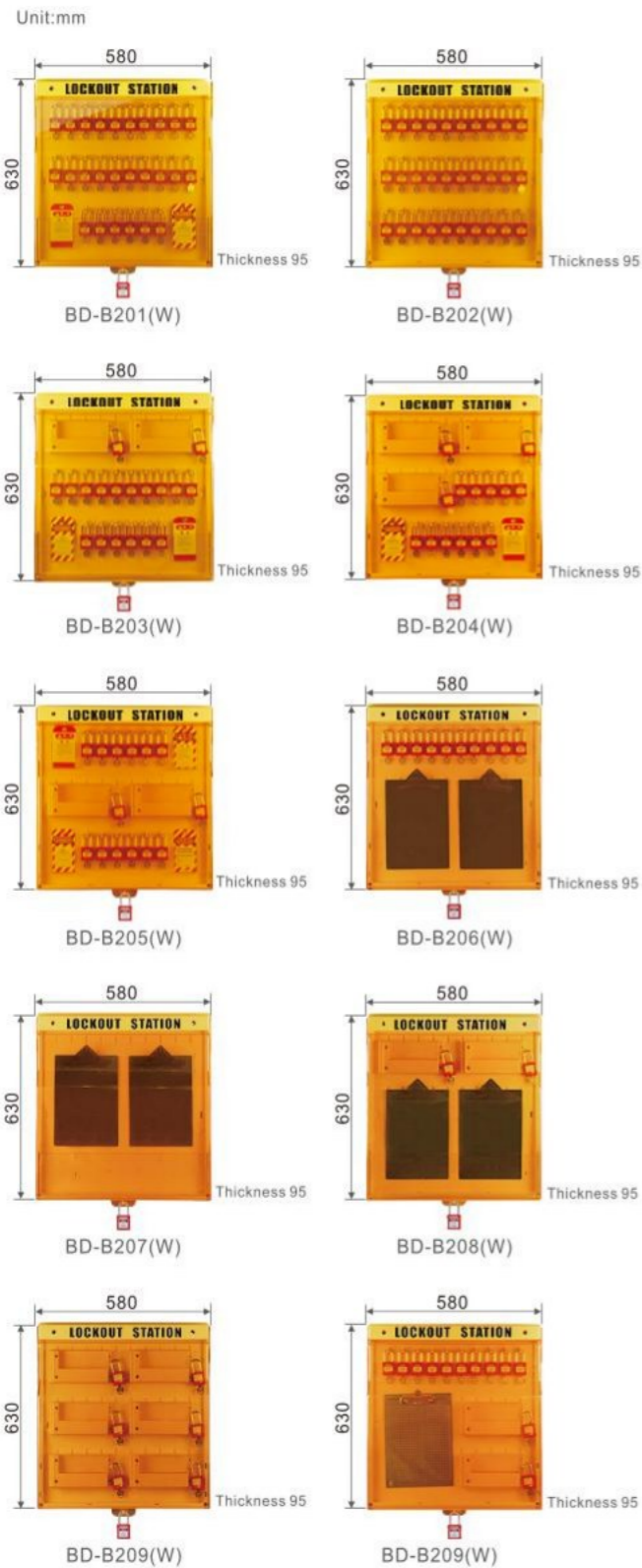

Instruction : The item adopts mask design."w" means lockout station without mask;board can be locked .

**Product Introduction**

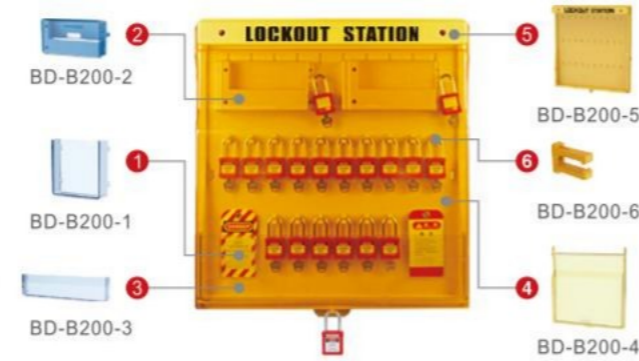

No.	Model	Material	Description
1	BD-B200-1	Engineering Plastic PC	Tag box: Store tags, can be used with hanging board
2	BD-B200-2		Mobile phone box: fixed with individual screws, can be used with hanging board
3	BD-B200-3		Store padlocks or small safety locks for use with board
4	BD-B200-4		Engineering mask: used with hanging board
5	BD-B200-5		Station board siding: used with face mark
6	BD-B200-6		Hanging plate clip: for hanging safety padlock or hasp

**Product Selection**

Model	Description
BD-B201(W)	There are 26 hook positions and 2 tag boxes, which can accommodate several padlocks, hasps, tags, cable ties, small locks, etc.
BD-B202(W)	There are 30 hook positions, which can accommodate several padlocks, hasps, etc.
BD-B203(W)	There are 16 hook positions, 2 mobile phone boxes, and 2 tag boxes, which can accommodate several padlocks, hasps, tags, cable ties, small locks, etc.
BD-B204(W)	There are 12 hook positions, 3 mobile phone boxes, and 2 tag boxes, which can accommodate several padlocks, hasps, tags, cable ties, small locks, etc.
BD-B205(W)	There are 12 hook positions, 2 mobile phone boxes, and 4 tag boxes, which can accommodate several padlocks, hasps, tags, cable ties, small locks, etc.
BD-B206(W)	There are 10 hook positions, 2 A4 writing boards, which can accommodate several padlocks, hasps, work tickets, etc.
BD-B207(W)	There are 2 A4 size writing boards, which can accommodate several work tickets, hang tags, cable ties, etc.
BD-B208(W)	There are 2 mobile phone boxes, 2 A4 writing boards, which can accommodate several work tickets, tags, cable ties, etc.
BD-B209(W)	There are 6 mobile phone boxes.
BD-B210(W)	There are 10 hook positions, 2 mobile phone boxes, and 1 A4 writing board, which can accommodate several padlocks, hasps, work tickets, etc.

**BD-301/B302  
 OPEN LOCKOUT STATION**

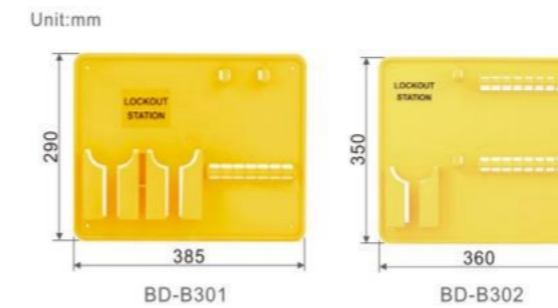

**BD-B31/B32/B33/B34  
 PADLOCK STATION**

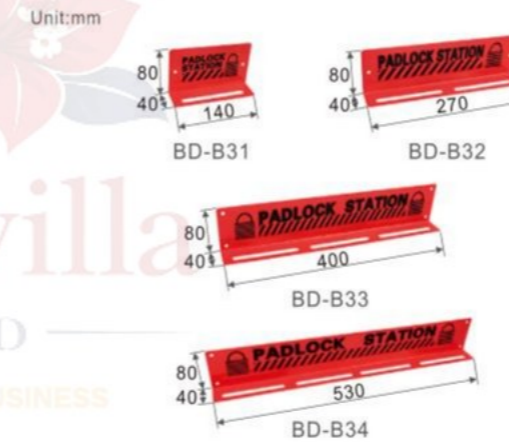

**BD-B41/B42  
 PORTABLE PADLOCK LOCKOUT**

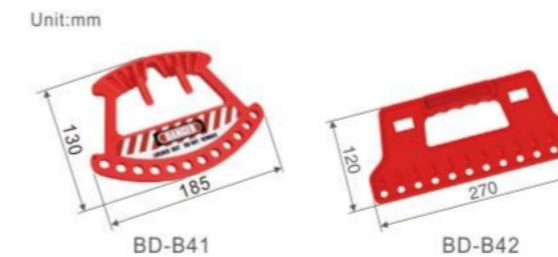

**Product Features**

- Made of PP material, the product is wear-resistant, corrosion-resistant and low-temperature resistant;
- It can be hung with various hasp, padlocks, hang tags, cable ties, etc.

**Product Selection**

Model	Description
BD-B301	2 hasp lock positions, 7 padlock positions, 2 tag positions
BD-B302	2 hasp lock positions, 16 padlock positions, 1 tag positions

**Product Features**

- Made of steel plate with high temperature spray surface.
- It has four sizes. Convenient for daily management of padlocks.

**Product Selection**

Model	Description
BD-B31	Can accommodate 5 padlocks
BD-B32	Can accommodate 10 padlocks
BD-B33	Can accommodate 15 padlocks
BD-B34	Can accommodate 20 padlocks

**Product Features**

- Made from injected engineering plastic reinforced nylon.
- BD-B41 has warning labels.
- The padlock and key can be carried and used at the same time.

**Product Selection**

Model	Description
BD-B41	Suitable for hanging up to 12 padlocks with lock shackle, other colors can be customized
BD-B42	

**BD-B51  
 SAFETY TAG STATION**

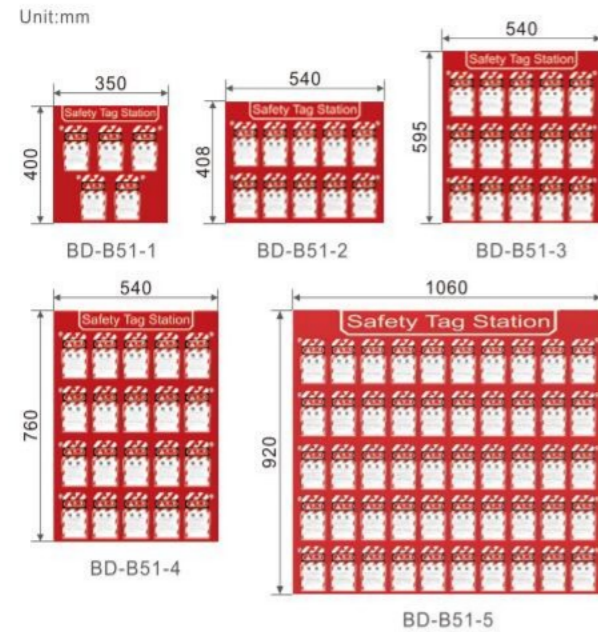

**Product Features**

- It is composed of steel plate with high temperature spray surface and a tag box made of engineering plastic PC.
- Can customize 5,10,15,20 tagout boxes.
- Can be customized different colors.

**Product Selection**

Model	Description
BD-B51-1	With 5 tagout boxes, each tagout box can accommodate 20 pieces tagout.
BD-B51-2	With 10 tagout boxes, each tagout box can accommodate 20 pieces tagout
BD-B51-3	With 15 tagout boxes, each tagout box can accommodate 20 pieces tagout
BD-B51-4	With 20 tagout boxes, each tagout box can accommodate 20 pieces tagout
BD-B51-5	With 50 tagout boxes, each tagout box can accommodate 20 pieces tagout

**BD-B4  
 PADLOCK STATION**

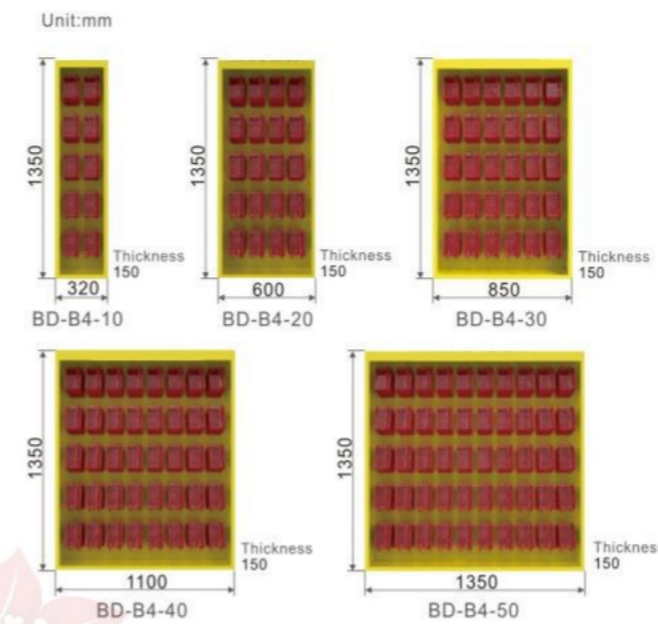

**Product Selection**

Model	Description
BD-B4-10	Can accommodate 10 boxes
BD-B4-20	Can accommodate 20 boxes
BD-B4-30	Can accommodate 30 boxes
BD-B4-40	Can accommodate 40 boxes
BD-B4-50	Can accommodate 50 boxes

**BD-B3  
 PADLOCK STATION**

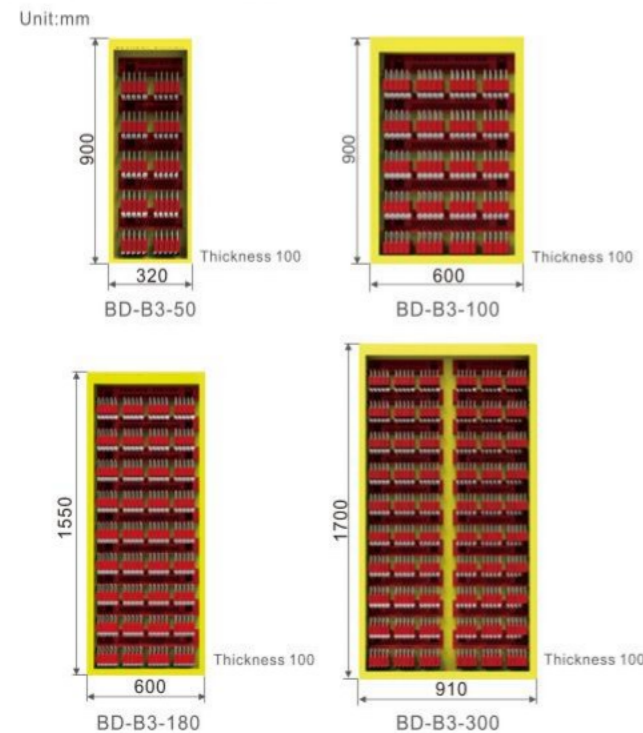

**Product Selection**

Model	Description
BD-B3-50	Can accommodate 50 padlocks, using with BD-B32(Quantity: 5)
BD-B3-100	Can accommodate 100 padlocks, using with BD-B34(Quantity: 5)
BD-B3-180	Can accommodate 180 padlocks, using with BD-B34(Quantity: 9)
BD-B3-300	Can accommodate 300 padlocks, using with BD-B33(Quantity:20)

**BD-B60~B66  
 KEY MANAGEMENT STATION**



**Product Introduction**

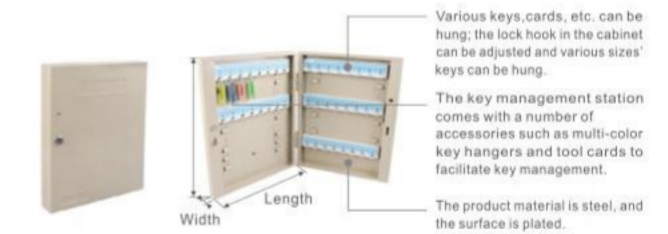

**Product Selection**

Model	Description
BD-B60	20 positions key management station, Length 210mm x Width 50mm x Height 380mm
BD-B61	32 positions key management station, Length 305mm x Width 50mm x Height 380mm
BD-B62	48 positions key management station, Length 305mm x Width 50mm x Height 500mm
BD-B63	60 positions key management station, Length 370mm x Width 60mm x Height 500mm
BD-B64	80 positions key management station, Length 370mm x Width 60mm x Height 620mm
BD-B65	160 positions key management station, Length 385mm x Width 100mm x Height 620mm
BD-B66	240 positions key management station, Length 385mm x Width 145mm x Height 620mm

Remarks: BD-B60 will send 2 additional hangers; BD-B61 will send 2 additional hangers; BD-B62 will send 2 additional hangers; BD-B63 will send 2 additional hangers; BD-B64 will send 2 additional hangers



**BD-B7  
 OPEN LOCKOUT STATION**

Unit:mm

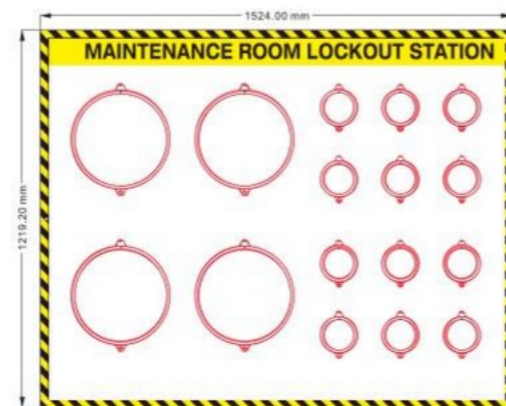
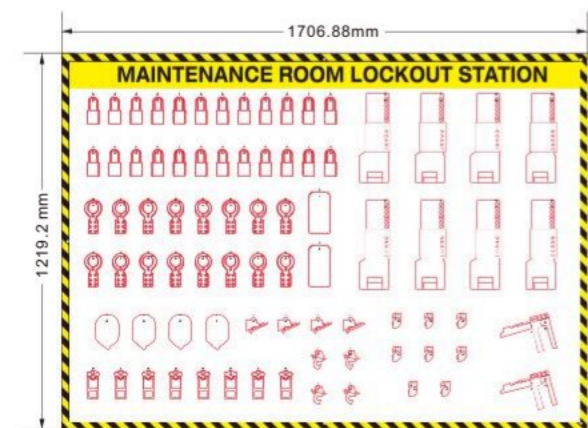
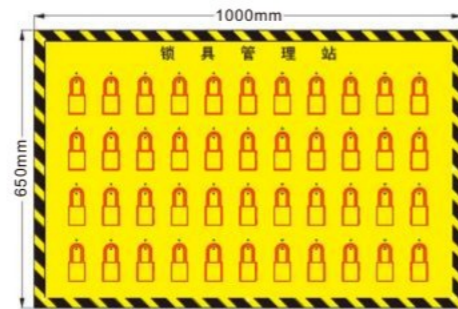
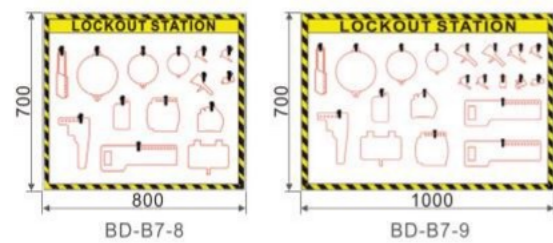
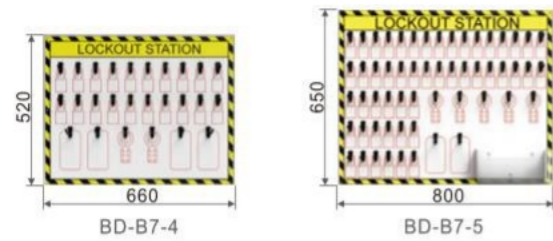
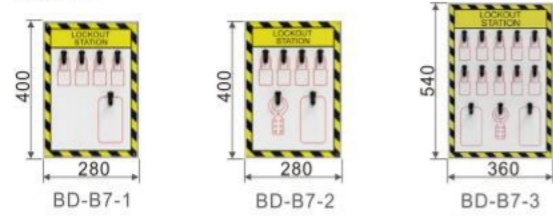

**Product Selection**

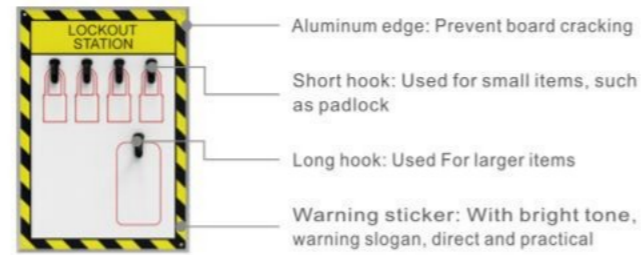

- Aluminum edge: Prevent board cracking
- Short hook: Used for small items, such as padlock
- Long hook: Used For larger items
- Warning sticker: With bright tone, warning slogan, direct and practical

**Product Features**

- Suitable for small companies and large departments to manage centrally.
- The board is made from hard plastic PVC, outer frame is made of aluminum in order to prevent it from falling down.
- Shadow contour is convenient to inventory and storage.
- Can customize design and logo etc.

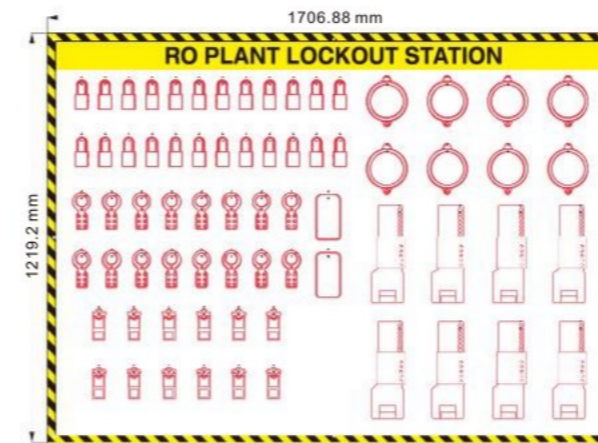

BD-B7-D48



**BD-B901  
 PULL ROD TYPE MOVABLE LOCKOUT STATION**

Unit:mm



Weight: 17.5Kg  
 Thickness: 0.81mm

BD-B901

**Product Selection**

Movable lockout station is divided into three layers, which is convenient for sorting and packing during maintenance. It has a thick and wear-resisting big roller, and the lockout station can move freely.



**BD-X01/X01T**  
 PORTABLE STEEL SAFETY LOCKOUT BOX



**Product Features**

- Made of steel plate with high temperature spray surface and a foldable handle.
- Several people can lock the important parts at the same time, can accommodate 12 padlocks.
- BD-X01T has transparent acrylic visual door panel, realizing visual management.

**Product Selection**

Model	Description
BD-X01	Can be used as mini portable lockout box; can accommodate several tags, hasps, mini lockouts etc.
BD-X01T	

**BD-X02**  
 PORTABLE STEEL SAFETY LOCKOUT BOX

Unit:mm



**Product Features**

- Made of steel plate with high temperature spray surface, the X02 is with a stainless steel handle.
- Several people can lock the important parts at the same time, can accommodate 12 padlocks.
- Can be used as mini portable lockout box, can accommodate several tagouts, hasps, mini lockouts etc.

**Product Selection**

Model	Description
BD-X02	Can be used as mini portable lockout box; can accommodate several tags, hasps, mini lockouts etc.

**BD-X03**  
 PORTABLE STEEL SAFETY LOCKOUT BOX

Unit:mm



BD-X03

**Product Features**

- Made of steel plate with high temperature spray surface, handle material is stainless steel and nylon.
- Device design for key store when large scale equipment shut down.
- Double function: wall-mounted or portable
- Up to 14 workers can lock it at the same time.
- Can be customized other colors.

**Product Selection**

Model	Description
BD-X03	Can be used as mini portable lockout box; can accommodate several tagouts, hasps, mini lockouts etc. Integrated storage space for orderly storage of up to 14 padlocks or hundreds of keys.

**BD-X04**  
 PORTABLE STEEL SAFETY LOCKOUT BOX

Unit:mm



**Product Features**

- Made of steel plate with high temperature spray surface, the X04 is with a stainless steel and nylon handle.
- Several people can lock the important parts at the same time, can accommodate 12 padlocks.

**Product Selection**

Model	Description
BD-X04	Can be used as mini portable lockout box; can accommodate several tags, hasps, mini lockouts etc.

**BD-X07**  
 LOCKOUT MANAGEMENT STATION

Unit:mm

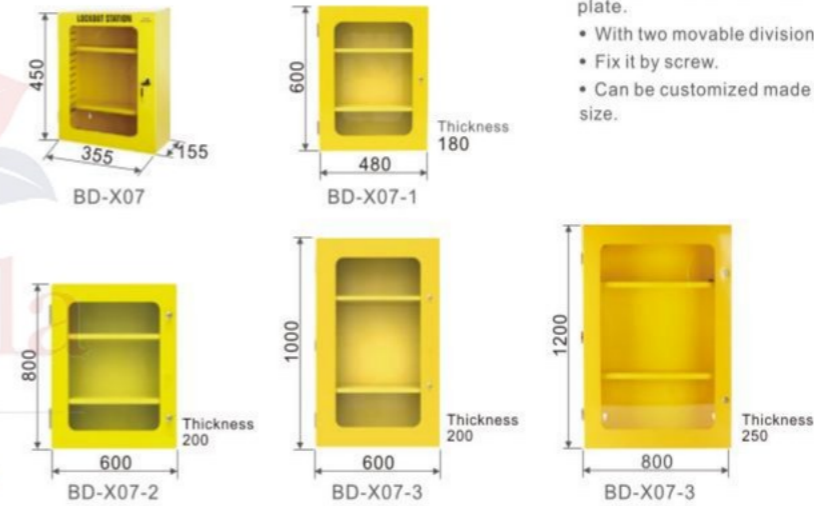

**Product Features**

- Made from surface high temperature spraying plastic treatment steel plate.
- With two movable division plates, can set the division space flexibly.
- Fix it by screw.
- Can be customized made non-perspective panel. Can customize bigger size.

**BD-X08/X09**  
 LOCKOUT MANAGEMENT STATION

Unit:mm

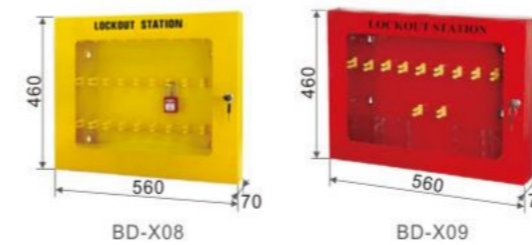

**Product Features**

- Made from surface high temperature spraying plastic treatment steel plate.
- Lockout management available.
- Can be customized opaque panels.

**Product Selection**

Model	Description
BD-X08	30 hook positions, each of which can hang two
BD-X09	22 hook positions and 4 tag boxes, each hook position can hang 2 padlocks and 2 hasps, and can hold about 40 tags.

LOCKOUT STATION

LOCKOUT STATION

**BD-X11/X12  
 PADLOCK STATION**

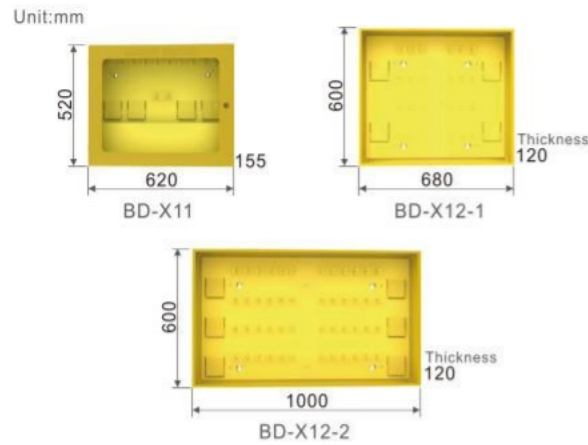

**Product Features**

- Made from surface high temperature spraying plastic treatment steel plate.
- Lockout management available.

**Product Selection**

Model	Description
BD-X11	12 hook positions and 4 card slots, each hook position can hang two padlocks or hasps.
BD-X12-1	24 hook positions and 4 card slots, each hook position can hang two padlocks or hasps.
BD-X12-2	48 hook positions and 6 card slots, each hook position can hang two padlocks or hasps.

**BD-X14/X15  
 WALL MOUNTED GRAY GROUP  
 LOCKOUT BOX**

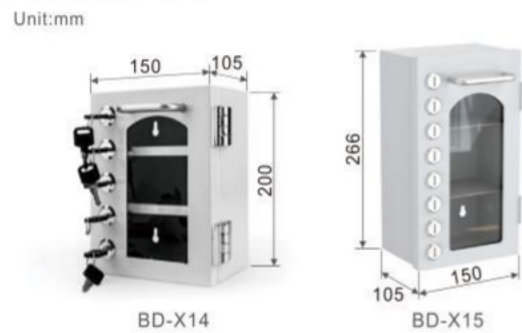

**Product Features**

- Made from surface high temperature spraying plastic treatment steel plate.
- Lockout management available.
- KA & KD & MK can be selected randomly.

**Product Selection**

Model	Description
BD-X14	With 5 cylinders
BD-X15	With 8 cylinders

**BD-X21  
 SMALL HANGING PLASTIC SAFETY  
 LOCKOUT BOX**

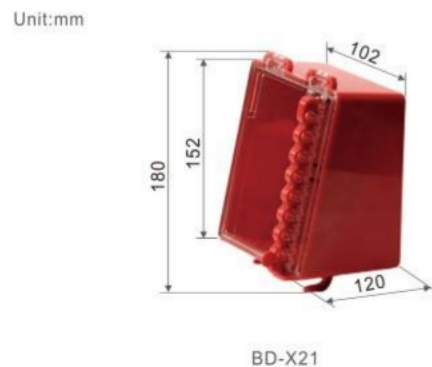

**Product Features**

- Made of engineering plastic ABS and PC.
- With transparent cover.
- Can be locked by padlocks with shackle Dia. less than 7mm
- Can be locked by 8 safety padlocks at the same time, convenient for management.

**Product Selection**

Model	Description
BD-X21	It has 6 hooks inside and 2 hooks outside.

**BD-X22  
 PORTABLE MULTIPURPOSE PLASTIC SAFETY  
 LOCKOUT BOX**



**Product Features**

- Made of engineering plastic ABS and PC.
- With transparent cover.
- Can be locked by padlocks with shackle Dia. less than 7mm
- Can be locked by 12 safety padlocks at the same time, convenient for management.

**Product Selection**

Model	Description
BD-X22	It has 6 hooks inside

**BD-X23  
 PORTABLE COMBINATION LOCKOUT BOX**



**Product Selection**

Model	Description
BD-X23A	With 10 padlock positions and 6 hook positions, can accommodate several padlocks, hasps, mini lockouts etc.
BD-X23B	With 10 padlock positions, 2 hook positions and 2 tags boxes, can accommodate several tagouts, hasps, mini lockouts etc.
BD-X23C	With 10 padlock positions and 3 tags boxes, can accommodate several padlocks, hasps, mini lockouts etc.
BD-X23D	With 10 padlock positions and 1 tags box,
BD-X23E	With 12 padlock positions, can accommodate several padlocks, hasps etc.

Remark: This product can be carried in hand or hang on the wall.  
 The mask can be locked.



**BD-X24**  
**WALL MOUNTED MULTIFUNCTIONAL LOCKOUT BOX**

Unit:mm

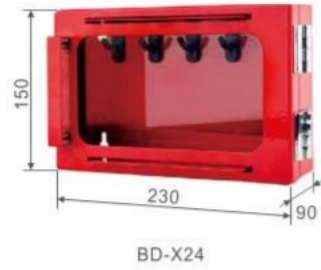

BD-X24

**BD-X26**  
**WALL-MOUNTED FUNCTIONAL SAFETY LOCKOUT BOX**

Unit:mm

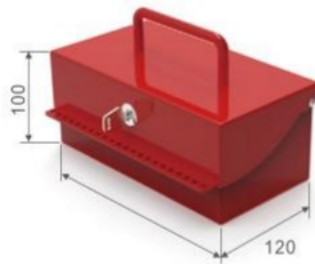

BD-X26

**BD-X27**  
**MULTIFUNCTIONAL SAFETY LOCKOUT BOX**

Unit:mm

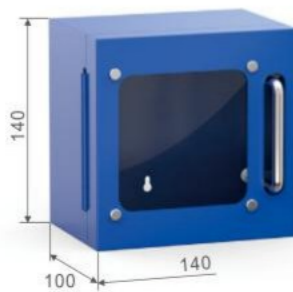

BD-X27

**Product Features**

- Made of steel plate with high temperature spray surface, it is not easy to oxidize and rust.
- Several people can lock the important parts at the same time, can accommodate 12 padlocks.
- It has transparent acrylic visual door panel, realizing visual management.

**Product Selection**

Model	Description
BD-X24	Can be used as mini portable lockout box; can accommodate several tags, hasps, mini lockouts etc.

**Product Features**

- The high-strength steel plate is stamped and the surface is treated with high-temperature plastic spray, which is not easy to oxidize and rust.
- Several people can lock the important parts at the same time, can accommodate 22 padlocks.

**Product Selection**

Model	Description
BD-X26	Can be used as mini portable lockout box; can accommodate several tags, hasps, mini lockouts etc.

**Product Features**

- Made of cold rolled steel plate is stamped and the surface is treated with high-temperature plastic spray, which is not easy to oxidize and rust.
- Several people can lock the important parts at the same time.

**Product Selection**

Model	Description
BD-X27	Can be used as mini portable lockout box; can accommodate several tags, hasps, mini lockouts etc.

**BD-X60/X61/X62**  
**LOCKOUT MANAGEMENT STATION**

Unit:mm



**BD-SX10**  
**LOCKOUT STATION**

Unit:mm

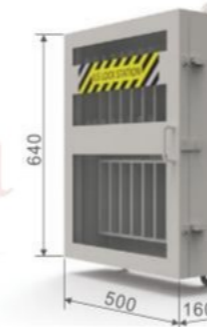

BD-SX10

**Product Features**

- Made of cold rolled steel plate is stamped and the surface is treated with high-temperature plastic spray.
- Double function: wall-mounted or portable.
- Several people can lock the important parts at the same time, can accommodate 22 padlocks.
- Other colors can be customized.

**Product Selection**

Model	Description
BD-X60	Composed of BD-X61 and BD-X62; With 1x A4 paper clip and 1 x BD-B42 hanger, can accommodate several job tickets, padlocks, keys, etc.
BD-X61	With 1x A4 paper clip and ,can accommodate several job tickets
BD-X62	With 1 x BD-B42 hanger, can accommodate several job tickets, padlocks, keys, etc.

**Product Features**

- Made of cold rolled steel plate is stamped and the surface is treated with high-temperature plastic spray, which is not easy to oxidize and rust.
- It has transparent acrylic visual door panel, realizing visual management.

**Product Selection**

Model	Description
BD-SX10	can accommodate 16 sets padlocks, 8pcs each set.

**BD-M01**  
**LARGE LOCKOUT DISPLAY STATION**

Unit:mm



BD-M01

**Product Features**

- Made of steel plate with high temperature spray surface, it is not easy to oxidize.

**Product Selection**

Model	Description
BD-M01	It consists of three parts: upper, middle and lower. The upper layer displays industrial electrical lockouts, the middle layer displays valves and other lockouts, and the lower layer is the storage location for lockouts.

LOCKOUT STATION

LOCKOUT STATION



**BD-M02**  
**MOVEABLE LOCKOUT DISPLAY STAND**

Unit:mm

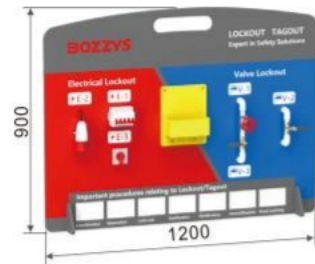

BD-M02

**Product Features**

- Made of KT plate.

**Product Selection**

Model	Description
BD-M02	Display the electrical lockout and valve lockout and key steps in the "lockout tagout" process.

**BD-X-D1**  
**LOCKOUT MANAGEMENT STATION**

Unit:mm

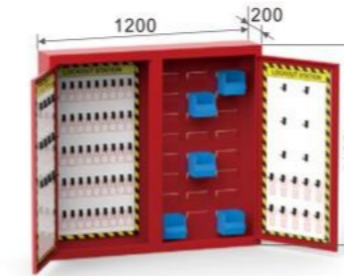

BD-X-D1

**Product Features**

- Made of Q235 cold rolled steel plate, the surface is treated by high temperature spray, not easy to oxidize and rust.

**Product Selection**

Model	Description
BD-X-D1	There are 3 customized BD-B7 base plates and 8 storage boxes, which can accommodate several padlocks, hasps, tags, cable ties, small locks, etc

**BD-S03**  
**COLLECTIVE STORAGE CABINET**

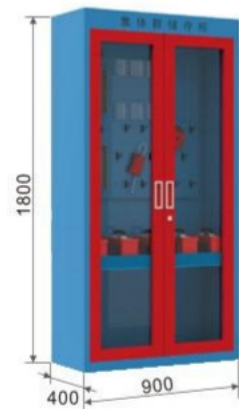

BD-S03

**Product Features**

- Made of sheet metal steel, surface is spray treated, not easy to oxidize.

**Product Selection**

Model	Description
BD-S03	It can store all kinds of lockout, can store 10 groups of padlock (10pcs / group), 10 tag boxes, 15 padlocks and several lockout boxes.

**BD-X-D2**  
**LOCKOUT MANAGEMENT STATION**

Unit:mm

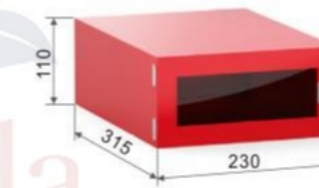

BD-X-D2

**Product Features**

- Made of Q235 cold rolled steel plate, the surface is treated by high temperature spray, not easy to oxidize and rust.
- Transparent acrylic door panel, to achieve visual management.

**Product Selection**

Model	Description
BD-X-D2	Can accommodate several padlocks, hasps, small locks, etc

**BD-B3-D1**  
**LOCKOUT MANAGEMENT STATION**

Unit:mm

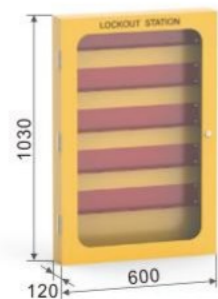

BD-B3-D1

**Product Features**

- Made of Q235 cold rolled steel plate, the surface is treated by high temperature spray, not easy to oxidize and rust.
- Transparent organic glass door panel, to achieve visual management.

**Product Selection**

Model	Description
BD-B3-D1	There are 5 lock hangers, which can hold 100 padlocks; 4 tag boxes, which can accommodate several tags, cable ties, etc

**BD-X-D3**  
**LOCKOUT MANAGEMENT STATION**

Unit:mm

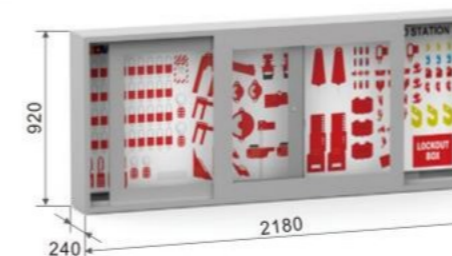

BD-X-D3

**Product Features**

- Made of Q235 cold rolled steel plate, the surface is treated by high temperature spray, not easy to oxidize and rust.
- Transparent acrylic door panel, to achieve visual management.

**Product Selection**

Model	Description
BD-X-D3	Customized BD-B7 base plates, can accommodate several padlocks, hasps, tags, cable ties, small locks, etc

LOCKOUT STATION

LOCKOUT STATION



**BD-X-D4**  
LOCKOUT MANAGEMENT STATION

Unit: mm



BD-X-D4

**BD-X-D5**  
LOCKOUT MANAGEMENT STATION

Unit: mm

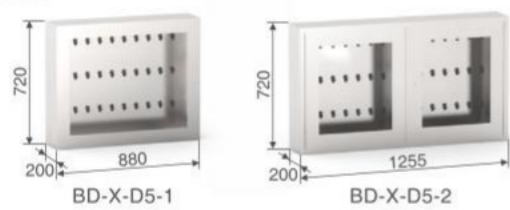

BD-X-D5-1

BD-X-D5-2

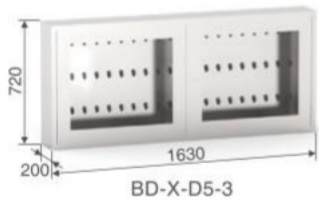

BD-X-D5-3

**BD-X07-D1**  
LOCKOUT MANAGEMENT STATION

Unit: mm



BD-X07-D1

**Product Features**

- Made of Q235 cold rolled steel plate, the surface is treated by high temperature spray, not easy to oxidize and rust.
- Transparent acrylic door panel, to achieve visual management.

Model	Description
BD-X-D4	There are 4 padlock boxes and 6 tag boxes, which can accommodate several padlocks, hasps, keys, tags, cable ties, small locks, etc

**Product Features**

- Made of Q235 cold rolled steel plate, the surface is treated by high temperature spray, not easy to oxidize and rust.
- Transparent acrylic door panel, to achieve visual management.

**Product Selection**

Model	Description
BD-X-D5-1	There are 30 hooks, which can accommodate several padlocks, hasp, etc
BD-X-D5-2	There are 45 hooks, which can accommodate several padlocks, hasp, etc
BD-X-D5-3	There are 60 hooks, which can accommodate several padlocks, hasp, etc

**Product Features**

- Made of Q235 cold rolled steel plate, the surface is treated by high temperature spray, not easy to oxidize and rust.
- Transparent organic glass door panel, to achieve visual management.

**Product Selection**

Model	Description
BD-X07-D1	There are 5 lock hangers, which can hold 100 padlocks

**BD-X07-D3**  
LOCKOUT MANAGEMENT STATION

Unit: mm



BD-X07-D3

**BD-X07-D5**  
LOCKOUT MANAGEMENT STATION

Unit: mm



BD-X07-D5

**BD-X09-D2**  
LOCKOUT MANAGEMENT STATION

Unit: mm

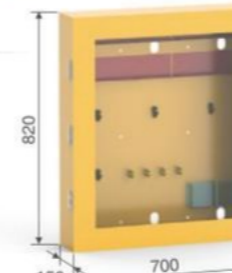

BD-X09-D2

**BD-X16-D1**  
LOCKOUT MANAGEMENT STATION

Unit: mm

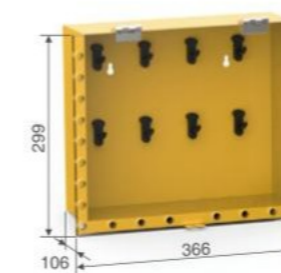

BD-X16-D1

**Product Features**

- Made of Q235 cold rolled steel plate, the surface is treated by high temperature spray, not easy to oxidize and rust.
- Transparent acrylic door panel, to achieve visual management.

**Product Selection**

Model	Description
BD-X07-D3	There are 2 partitions, which can be freely disassembled and combined: it can accommodate several padlocks, hasps, small locks, etc

**Product Features**

- Made of Q235 cold rolled steel plate, the surface is treated by high temperature spray, not easy to oxidize and rust.
- Transparent acrylic door panel, to achieve visual management.

**Product Selection**

Model	Description
BD-X07-D5	There are 50 black hooks, 3 large yellow hooks, which can accommodate several padlocks, hasps, tags, cable ties, small locks, etc

**Product Features**

- Made of Q235 cold rolled steel plate, the surface is treated by high temperature spray, not easy to oxidize and rust.
- Transparent organic glass door panel, to achieve visual management

**Product Selection**

Model	Description
BD-X09-D2	Built-in 4 lock hangers, which can accommodate 50 padlocks; There are 4 small black hooks, 4 large yellow hooks, 2 tag boxes, 1 partition, which can accommodate several hasps, tags, cable ties, small locks, etc

**Product Features**

- Made of Q235 cold rolled steel plate, the surface is treated by high temperature spray, not easy to oxidize and rust.
- Can realize multiple people to lockout the important parts at the same time, can hang up to 24 padlocks.
- Transparent PC door panel, to achieve visual management.

**Product Selection**

Model	Description
BD-X16-D1	There are 8 hooks, which can accommodate several padlocks, hasps, etc

**XPG SERIES  
 LOCKOUT STATION**

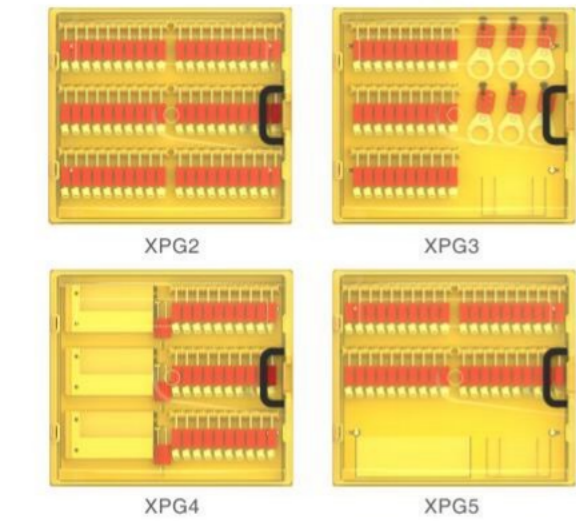

XPG1

**Product Selection**

Model	Weight	Description
XPG1 套装:TXPG1	3.25	Can accommodate 20 padlocks, 4 hasps several tags and cable tie
XPG2 套装:TXPG2	5.3	Can accommodate 60 padlocks
XPG3 套装:TXPG3	5.3	Can accommodate 30 padlocks, 6 hasps several tags and cable ties
XPG4 套装:TXPG4	5.8	Can accommodate 30 padlocks, several tags, cable ties and small locks
XPG5 套装:TXPG5	10	Can accommodate 40 padlocks, several tags, cable ties and small locks

This series station does not include lockout.  
 If need with lockout, please purchase the Kit Series.

**BD-XM1/XM2/XM3  
 PORTABLE SAFETY LOCKOUT BOX**

Unit: mm



**Product Features**

- Made of steel plate with high-temperature spray surface ;
- Lockout storage allows multiple people to lock and manage at the same time
- Device design for Key storage when large scale equipment shut down

**Product Selection**



**Product Selection**

Model	Description
BD-XM1	Device design for Key storage when large scale equipment shut down
BD-XM2	Device design for Key storage when large scale equipment shut down
BD-XM3	Device design for Key storage when large scale equipment shut down

**XPS SERIES  
 LOCKOUT STATION**

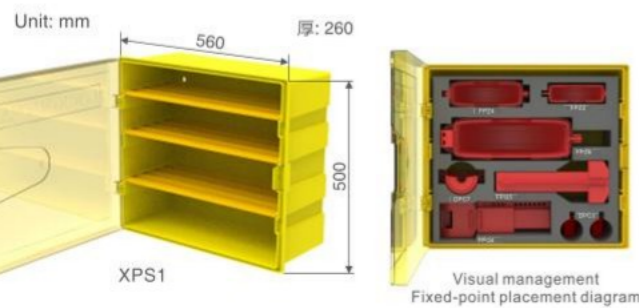

**Product Features**

- Made from PC ;
- Suitable for large LOTO device storage and management. ;
- Customizable fixed-point diagram schemes are available to facilitate lockout management.

**Product Selection**

Model	Description
XPS1	Suitable for large LOTO device storage and management.

This series station does not include lockout.

**XP1-P01  
 Safety Lockout Box**

Unit: mm

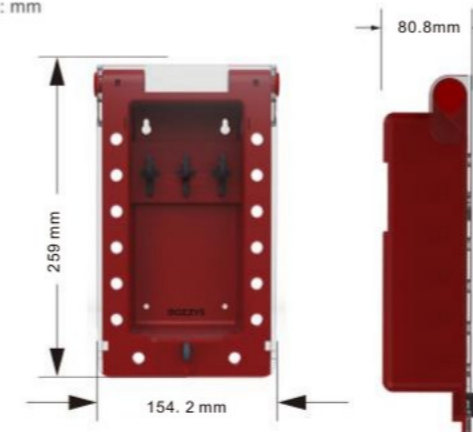

**Product Selection**

- Equipped with 3 hooks for cable ties, keys;
- Up to 15 safety padlocks can be used simultaneously for easy management;
- Center embedded lock hole removable to prevent damage during transport;
- Transparent cover design allows for visual inspection.

XP1-P01	XP1-P02	XP1-P03

LOCKOUT STATION

LOCKOUT STATION

## General Control Center And Sub-control Center Example

Central control center has locks; sub-control center does not.

Case 1: An automated workshop in a factory has few on-site personnel but many managed equipment, with most tasks dispatched from the central control center. Implementation Solution: Locks and information modules are located in the central control center; only the information module records locking operations on-site.



main control center

### SP-D14 Portable Presentation Board

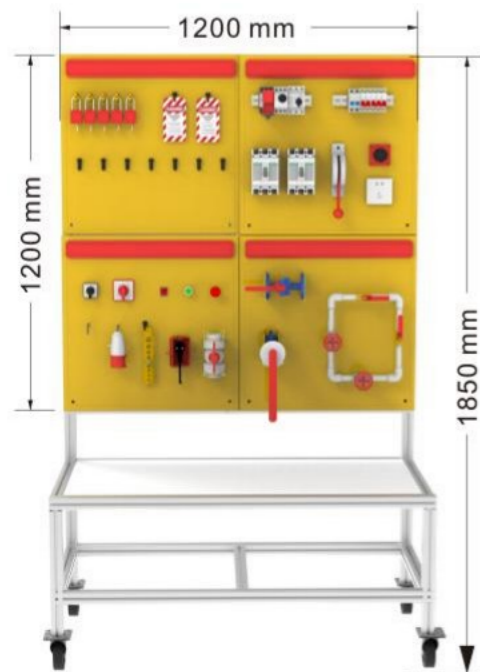

#### Product Features

- This product is suitable for practical demonstration and centralized management of company equipment. Customized PC boards and metal brackets are available according to customer requirements. Customized fixed placement solutions can be provided to facilitate lock management.

#### Product Selection

Model	Description
SP-D14	Suitable for demonstrating LOTO (Lockout/Tagout) procedures

### SP-D38 Portable Presentation Board

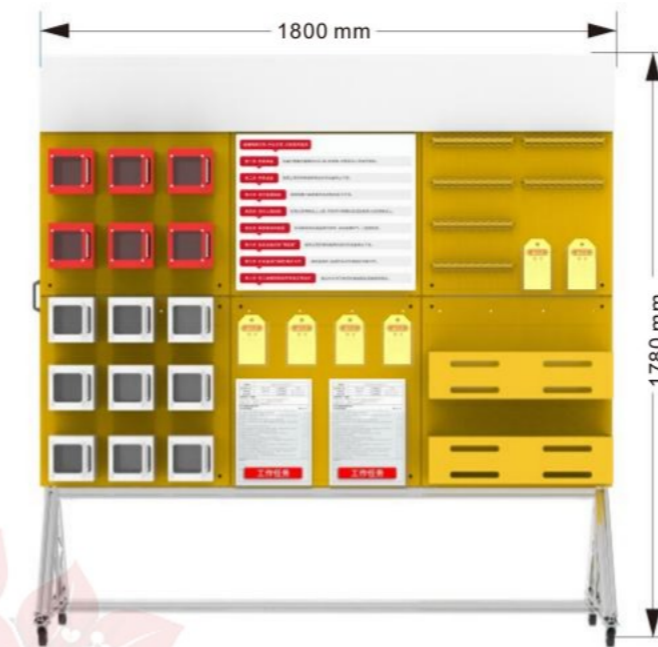

#### Product Features

- This product is suitable for practical demonstration and centralized management of company equipment. Customized PC boards and metal brackets are available according to customer requirements. Customized fixed placement solutions can be provided to facilitate lock management.

#### Product Selection

Model	Description
SP-D38	Suitable for demonstrating LOTO (Lockout/Tagout) procedures

### SP-D63 Portable Presentation Board



#### Product Features

- This product is suitable for practical demonstration and centralized management of company equipment. Customized PC boards and metal brackets are available according to customer requirements. Customized fixed placement solutions can be provided to facilitate lock management.

#### Product Selection

Model	Description
SP-D63	Suitable for demonstrating LOTO (Lockout/Tagout) procedures

LOCKOUT STATION

LOCKOUT STATION

# WAIST BAG / COMBINATION BAG



## BD-Z01 SAFETY LOCKOUT WAIST BAG

Unit:mm



### Product Features

- Made of wear-resistant polyester cloth.
- Can customize the surface label content of bag for customers, such as XX department of XX company.

## BD-Z02 SAFETY LOCKOUT HANDBAG

Unit:mm



### Product Features

- Made of wear-resistant polyester cloth.
- Can customize the surface label content of bag for customers, such as XX department of XX company.

## BD-Z03 SAFETY LOCKOUT PORTABLE BOX

Unit:mm



### Product Features

- Made of coated iron sheet and engineering plastic PP.
- Can customize the surface label content of bag for customers, such as XX department of XX company.

## BD-Z04 SAFETY LOCKOUT HANDBAG

Unit:mm



### Product Features

- Made of wear-resistant polyester cloth.
- Can customize the surface label content of bag for customers, such as XX department of XX company.

## BD-Z05 SAFETY LOCKOUT HANDBAG

Unit:mm



### Product Features

- Made of wear-resistant polyester cloth.
- Can customize the surface label content of bag for customers, such as XX department of XX company.

WAIST BAG/COMBINATION BAG

**BD-Z06**  
SAFETY LOCKOUT WAIST BAG

Unit:mm



**BD-Z30**  
SAFETY LOCKOUT PORTABLE BOX

Unit:mm



**BD-ZT1**  
SAFETY LOCKOUT HANDBAG

Unit:mm

Thickness:80



(manual measurement error 1-2cm)

**BD-Z10**  
SAFETY LOCKOUT COMBINATION BAG



**Product Features**

- Made of engineered Oxford fabric.
- Can customize the surface label content of bag for customers, such as XX department of XX company.

**Product Features**

- Made of ABS.
- There's a partition inside, can customize the lockout kit for customers.

**Product Features**

- The lockout bag is made of wear-resistant polyester cloth;
- The lockout bag label content can be customized, such as XX company, XX department, etc.;
- Includes operator information badge window, visual key window, and belt fastening Velcro (belt not included), you can easily view lockout bag user information, manage keys and carry the lockout bag with you.

**Product List**

Description	Part code	Qty.
Safety lockout waist bag	BD-Z01	1
Short steel shackle safety padlock (Blue)	BD-G53	1
Nylon shackle safety padlock (Black)	BD-G15	1
Double-end aluminum hasp	BD-K61	1
Nylon lockout hasp	BD-K44	1
Multi-function circuit breaker lockout	BD-D14	1
Multi-function circuit breaker lockout	BD-D15	1
Safety tag	BD-P01	10

**BD-Z07**  
SHUTDOWN MAINTENANCE LOCKOUT BAG

Unit:mm



**BD-Z08**  
SHUTDOWN MAINTENANCE LOCKOUT BAG

Unit:mm



**BD-Z09**  
SHUTDOWN MAINTENANCE LOCKOUT BAG

Unit:mm



**Product Features**

- Made of engineered Oxford fabric.
- Can customize the surface label content of bag for customers, such as XX department of XX company.

**Product Features**

- Made of engineered Oxford fabric.
- Portable hand-held design, suitable for storing, placing and carrying locks and tools during personal operation and maintenance.

**Product Features**

- Made of engineered Oxford fabric.
- Portable hand-held design, suitable for storing, placing and carrying locks and tools during personal operation and maintenance.



**BD-Z14**  
**SAFETY LOCKOUT COMBINATION BOX**



Nylon lockout hasp

**Product List**

Description	Part code	Qty.
Safety lockout portable box	BD-Z30	1
Steel shackle safety padlock	BD-G01	5
Double-end aluminum hasp	BD-K61	2
Nylon lockout hasp	BD-K43	1
Nylon lockout hasp	BD-K44	1
Industrial water proof plug lockout	BD-D46	1
Multi-function circuit breaker lockout	BD-D14	4
Multi-function circuit breaker lockout	BD-D15	2
Large type circuit breaker lockout	BD-D16	1
Automatic retractable cable lockout	BD-L41	1
Adjustable gate valve lockout	BD-F16	1
Safety tag	BD-P01	10

**BD-Z15**  
**SAFETY LOCKOUT COMBINATION BOX**



**Product List**

Description	Part code	Qty.
Safety lockout portable box	BD-Z30	1
Aluminum lockout hasp (Red)	BD-K53	1
PA coated steel hasp	BD-K01	1
PA coated steel hasp	BD-K02	1
Nylon lockout hasp	BD-K42	1
Aluminum lockout hasp	BD-K11	1
Aluminum lockout hasp	BD-K12	1
Clamp-on breaker lockout (Small)	BD-D11X	1
Clamp-on breaker lockout (Medium)	BD-D12X	1
Clamp-on breaker lockout (Large)	BD-D13X	1
Miniature circuit breaker lockout	BD-D01	1
Miniature circuit breaker lockout	BD-D02	1
Miniature circuit breaker lockout	BD-D03	1
Miniature circuit breaker lockout	BD-D04	1
Steel shackle safety padlock	BD-G01	5
Nylon shackle safety padlock	BD-G11	5
Electrical plug lockout (Medium)	BD-D42	1
Electrical plug lockout (Large)	BD-D43	1
Emergency stop lockout	BD-D51	1
Emergency stop lockout	BD-D52	1
Emergency stop lockout	BD-D53	1
Safety tag	BD-P01	10

**BD-Z16**  
**SAFETY LOCKOUT KIT**



**Product List**

Description	Part code	Qty.
Lockout station	BD-B201	1
Gate valve lockout	BD-F11	1
Gate valve lockout	BD-F12	1
Gate valve lockout	BD-F13	1
Gate valve lockout	BD-F14	1
Gate valve lockout	BD-F15	1
Safety lockout portable box	BD-Z30	1
Aluminum lockout hasp (Red)	BD-K53	1
PA coated steel hasp	BD-K01	1
PA coated steel hasp	BD-K02	1
Nylon lockout hasp	BD-K42	1
Aluminum lockout hasp	BD-K11	1
Aluminum lockout hasp	BD-K12	1
Clamp-on breaker lockout (small)	BD-D11X	1
Clamp-on breaker lockout (Medium)	BD-D12X	1
Clamp-on breaker lockout (Large)	BD-D13X	1
Miniature circuit breaker lockout	BD-D01	1
Miniature circuit breaker lockout	BD-D02	1
Miniature circuit breaker lockout	BD-D03	1
Miniature circuit breaker lockout	BD-D04	1
Steel shackle safety padlock (Red)	BD-G01	5
Nylon shackle safety padlock (Red)	BD-G11	5
Electrical plug lockout (Medium)	BD-D42	1
Electrical plug lockout (Large)	BD-D43	1
Emergency stop lockout	BD-D51	1
Emergency stop lockout	BD-D52	1
Emergency stop lockout	BD-D53	1
Safety tag	BD-P01	10

**BD-Z19**  
**SAFETY LOCKOUT COMBINATION BAG**



**Product List**

Description	Part code	Qty.
Safety lockout handbag	BD-Z04	1
Steel shackle safety padlock (Red)	BD-G01	6
Medium circuit breaker lockout	BD-D17	4
Medium circuit breaker lockout	BD-D18	2
Aluminum lockout hasp (Red)	BD-K45	1
Adjustable cable lockout (4mm)	BD-L11	1
Electrical plug lockout (Small)	BD-D41A	1
Electrical plug lockout (Large)	BD-D42A	1
Universal wall-type switch lockout	BD-D23	2
Steel hasp with hook	BD-K21	1
Gun lock	BD-QS01	2
Safety tag	BD-P01	10
Portable transparent storage box	BD-E01	2



**BD-Z20**  
**SAFETY LOCKOUT COMBINATION BAG**



Product List		
Description	Part code	Qty.
Safety lockout handbag	BD-Z05	1
Nylon shackle safety padlock (Red)	BD-G11	1
Nylon lockout hasp	BD-K43	1
Medium circuit breaker lockout	BD-D17	1
Medium circuit breaker lockout	BD-D18	1
Clamp-on breaker lockout (Medium)	BD-D12X	1
Miniature circuit breaker lockout	BD-D01	1
Miniature circuit breaker lockout	BD-D02	1
Miniature circuit breaker lockout	BD-D03	1
Miniature circuit breaker lockout	BD-D04	1
Simple circuit breaker lockout	BD-D05-1	1
Simple circuit breaker lockout	BD-D05-2	1
Safety tag	BD-P01	10

**BD-Z22**  
**SAFETY LOCKOUT COMBINATION BAG**



Product List		
Description	Part code	Qty.
Safety lockout waist bag	BD-Z06	1
Gun lock	BD-QS01	1
Steel hasp with hook	BD-K21	1
Medium circuit breaker lockout	BD-D17	2
Medium circuit breaker lockout	BD-D18	1
Steel shackle safety padlock	BD-G01	1
Safety tag	BD-P01	10

**BD-ZT30**  
**SAFETY LOCKOUT KIT**



Product List		
Description	Part code	Qty.
self-locking miniature circuit breaker lockout	BD-DPX1	4
self-locking switch lockout	BD-DPJ1	2
self-locking plug lock box	BD-DPC1	1
self-locking plug lock box	BD-DPC2	1
self-locking circuit breaker lockout	BD-DPD1	4
self-locking circuit breaker lockout	BD-DPD2	2
safety insulated padlocks (small size)	BD-G311	1
KA	KEYS	4

**BD-Z11**  
**SAFETY LOCKOUT COMBINATION BAG**



Product List		
Description	Part code	Qty.
Safety lockout handbag	BD-Z02	1
Short steel shackle safety padlock (Blue)	BD-G53	1
Nylon shackle safety padlock (Black)	BD-G15	1
Double-end aluminum hasp	BD-K61	1
Nylon lockout hasp	BD-K44	1
Multi-function circuit breaker lockout	BD-D14	1
Multi-function circuit breaker lockout	BD-D15	1
Safety tag	BD-P01	10
Adjustable ball valve lockout	BD-F01	1
Gate valve lockout	BD-F11	1

**BD-Z12**  
**SAFETY LOCKOUT COMBINATION BAG**



Product List		
Description	Part code	Qty.
Safety lockout handbag	BD-Z02	1
Nylon shackle safety padlock (Black)	BD-G15	1
Steel shackle safety padlock (Red)	BD-G01	1
Steel shackle safety padlock (Yellow)	BD-G02	1
Nylon lockout hasp	BD-K42	1
Double-end aluminum hasp	BD-K61	1
Aluminum lockout hasp	BD-K11	1
Adjustable ball valve lockout	BD-F01	1
Gate valve lockout	BD-F11	1
Automatic retractable cable lockout	BD-L41	1
Multi-function circuit breaker lockout	BD-D14	2
Multi-function circuit breaker lockout	BD-D15	2
Safety tag	BD-P01	10

**BD-Z13**  
**SAFETY LOCKOUT COMBINATION BAG**



Product List		
Description	Part code	Qty.
Safety lockout handbag	BD-Z02	1
Nylon shackle safety padlock (Yellow)	BD-G12	1
Nylon shackle safety padlock (Black)	BD-G15	1
Nylon shackle safety padlock (Orange)	BD-G17	1
Long nylon shackle safety padlock (Green)	BD-G34	1
Nylon lockout hasp	BD-K43	1
Nylon lockout hasp	BD-K44	1
Aluminum lockout hasp	BD-K11	1
Multi-function circuit breaker lockout	BD-D14	2
Multi-function circuit breaker lockout	BD-D15	2
Large type circuit breaker lockout	BD-D16	1
Adjustable cable lockout (4mm)	BD-L11	1
Electrical plug lockout (Medium)	BD-D42	1
Safety tag	BD-P01	10



SAFETY LOCKOUT KIT

SAFETY LOCKOUT KIT

**BD-Z31**  
SAFETY LOCKOUT HANDBAG



**BD-Z32**  
SAFETY LOCKOUT HANDBAG



**BD-Z33**  
SAFETY LOCKOUT HANDBAG



**Product Features**

- Made of engineered Oxford fabric.
- Can customize the surface label content of bag for customers, such as XX department of XX company.

**Product Features**

- Made of engineered Oxford fabric.
- Can customize the surface label content of bag for customers, such as XX department of XX company.

**Product Features**

- Made of engineered Oxford fabric.
- Can customize the surface label content of bag for customers, such as XX department of XX company.



# SEAL LOCK



**BD-QF05~QF08**  
**HIGH SECURITY BULLET LEAD SEAL LOCK**

Unit: mm

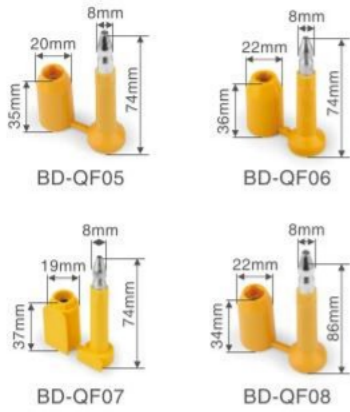

**Product Features**

- Lock shell material is new ABS eco-friendly plastic.
- Lock rod and barrel are made of Q235 steel, maximum tension can up to 1T.

**Product Selection**

Model	Description
BD-QF05	It is suitable for anti-theft locking of trucks and containers.
BD-QF06	
BD-QF07	
BD-QF08	

**Steps For Usage**

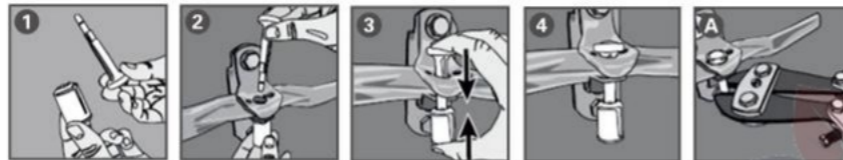

**BD-QS01**  
**PLASTIC COATED LAMINATED STEEL CABLE GUN LOCK**

Unit: mm



**Product Features**

- Laminated steel lock body: rubber protective layer prevent the gun body from corrosion wear, solid and durable.
- Application: suitable for most rifles, shotguns, pistols and trigger guns, etc.
- Function: keep the gun body locked so that the gun can't be used to prevent accidents.

**Product Selection**

Model	Description	Application
BD-QS01	Net weight is 0.15KG, with 2 keys.	

**Application**



**BD-QF01**  
**HEXAGONAL PLASTIC LEAD SEAL LOCK**

Unit: mm

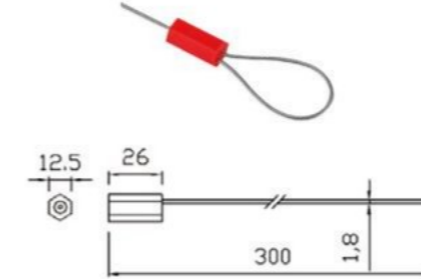

**Product Features**

- Coated with new ABS eco-friendly plastic, core of lock body is zinc alloy.
- Lock cable material is aviation steel cable, Dia. is 1.8mm.
- The maximum tension can up to 200KG.
- Can customize colors, any text graphics, laser printing, heat transfer printing.

**Product Selection**

Model	Description
BD-QF01	Standard steel cable length is 300mm, can be customized.

**BD-QF02**  
**SQUARE PLASTIC LEAD SEAL LOCK**

Unit: mm

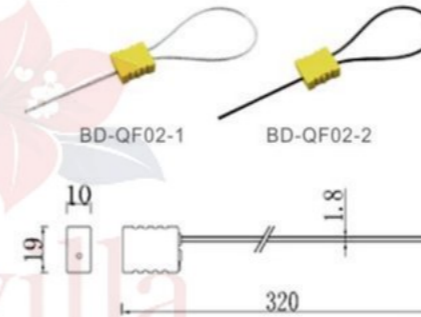

**Product Features**

- Aviation steel cable Dia. is 1.8mm, black plastic coated steel cable Dia. is 2.0mm.
- The maximum tension can up to 200KG.
- Can customize colors, any text graphics, laser printing, heat transfer printing.

**Product Selection**

Model	Description
BD-QF02-1	Standard steel cable length is 320mm, can be customized.
BD-QF02-2	

**BD-QF03/QF04**  
**ALUMINUM ALLOY STEEL CABLE LEAD SEAL LOCK**



BD-QF03



BD-QF04

**Product Features**

- Lock body is made of high quality aluminum alloy.
- Lock cable material is high quality aviation steel cable.
- Lock body color can be customized.

**Product Features**

Model	Description
BD-QF03-1	Steel cable: dia. 1.5mm x length 300mm; Max tension: 300kg
BD-QF03-2	Steel cable: dia. 2.0mm x length 300mm; Max tension: 450kg
BD-QF03-3	Steel cable: dia. 2.5mm x length 300mm; Max tension: 500kg
BD-QF03-4	Steel cable: dia. 4.0mm x length 300mm; Max tension: 1000kg
BD-QF03-5	Steel cable: dia. 5.0mm x length 300mm; Max tension: 1200kg
BD-QF04-1	Steel cable: dia. 1.5mm x length 300mm; Max tension: 300kg
BD-QF04-2	Steel cable: dia. 1.8mm x length 300mm; Max tension: 450kg
BD-QF04-3	Steel cable: dia. 2.5mm x length 300mm; Max tension: 500kg
BD-QF04-4	Steel cable: dia. 4.0mm x length 300mm; Max tension: 1000kg
BD-QF04-5	Steel cable: dia. 5.0mm x length 300mm; Max tension: 1200kg

SEAL LOCK

SEAL LOCK

# GIOVE CLIP



## AJ100 SERIES Glove Clip

Unit: mm



### Product Features

- Made of engineering plastic POM;
- Can be used to fix light and small items, such as gloves, towels, equipment bag keys, etc.;
- Small and versatile, easy to hang and not take up space

### Product Selection

Model	Dimensions (length*clip width*clip width)	Application
AJ100	125mm*29.5mm*29.5mm	
AJ110	140mm*29.5mm*35mm	
AJ120	162mm*35mm*35mm	

### Product appearance

AJ101	AJ102	AJ103	AJ104	AJ105	AJ106	AJ107
AJ111	AJ112	AJ113	AJ114	AJ115	AJ116	AJ117
AJ121	AJ122	AJ123	AJ124	AJ125	AJ126	AJ127





# MSDS BOX



**AH100  
 MSDS BOX**

Unit: mm



**Product Features**

- Material: PA+ABS and PC
- One-piece injection molding: It adopts one-piece injection molding, which is waterproof, dustproof and durable;
- Visual design: The files clearly classified marked, quickly find the required content in the box;
- Strong magnet on the back, which can be directly attached to the metal cabinet without punching, Easily moved to other required places;
- The built-in locking parts can be locked with ≤ 6mm thin shackle padlock to prevent accidental touch;

**Product Selection**

Model	Description	Application
AH100	Guidelines for safe storage at installation sites Emergency plan Important documents such as inventory lists and safety data sheets And ensure that the necessary personnel can access it at any time	

**AH200  
 MSDS BOX**

Unit: mm



**Product Features**

- Material: Cold-rolled Steel Plate
- One-piece injection molding: It adopts one-piece injection molding, which is waterproof, dustproof and durable;
- Visual design: The files clearly classified marked, quickly find the required content in the box;

**Product Selection**

Model	Description	Application
AH200	For safely storing important documents such as instruction manuals, emergency plans, inventory lists, safety data sheets, etc. at the installation site, and ensuring that personnel in need can access them at any time.	

**XP2-B01  
 Filing Cabinet**



**Product Features**

- Convenient to remove from the filing cabinet
- Ip65 Waterproof Rating
- The embedded central keyhole is detachable to prevent breakage during transport
- Transparent cover design allows for visual inspection.

**Product Selection**

XP2-B01	XP2-B02	XP2-B03



MSDS BOX

DATA BOX